

# Példák Turing-gépekre

**Fülöp Zoltán**

`fulop@inf.u-szeged.hu`

**SZTE TTK Informatikai Tanszékcsoport**

**Számítástudomány Alapjai Tanszék**

**6720 Szeged, Árpád tér 2.**

# A palindromákat eldöntő Turing-gép

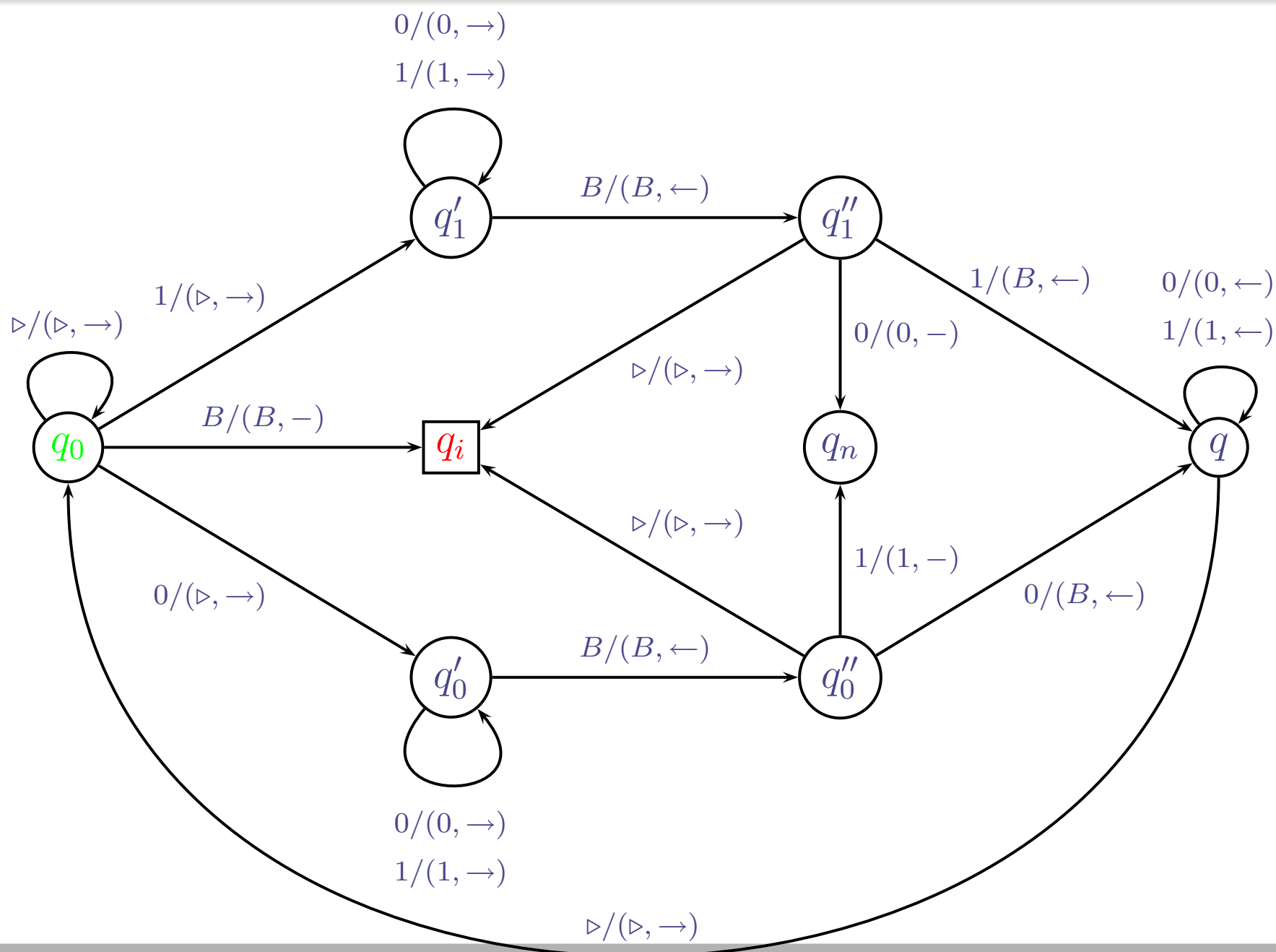

# A palindromákat eldöntő Turing-gép



$q_0$

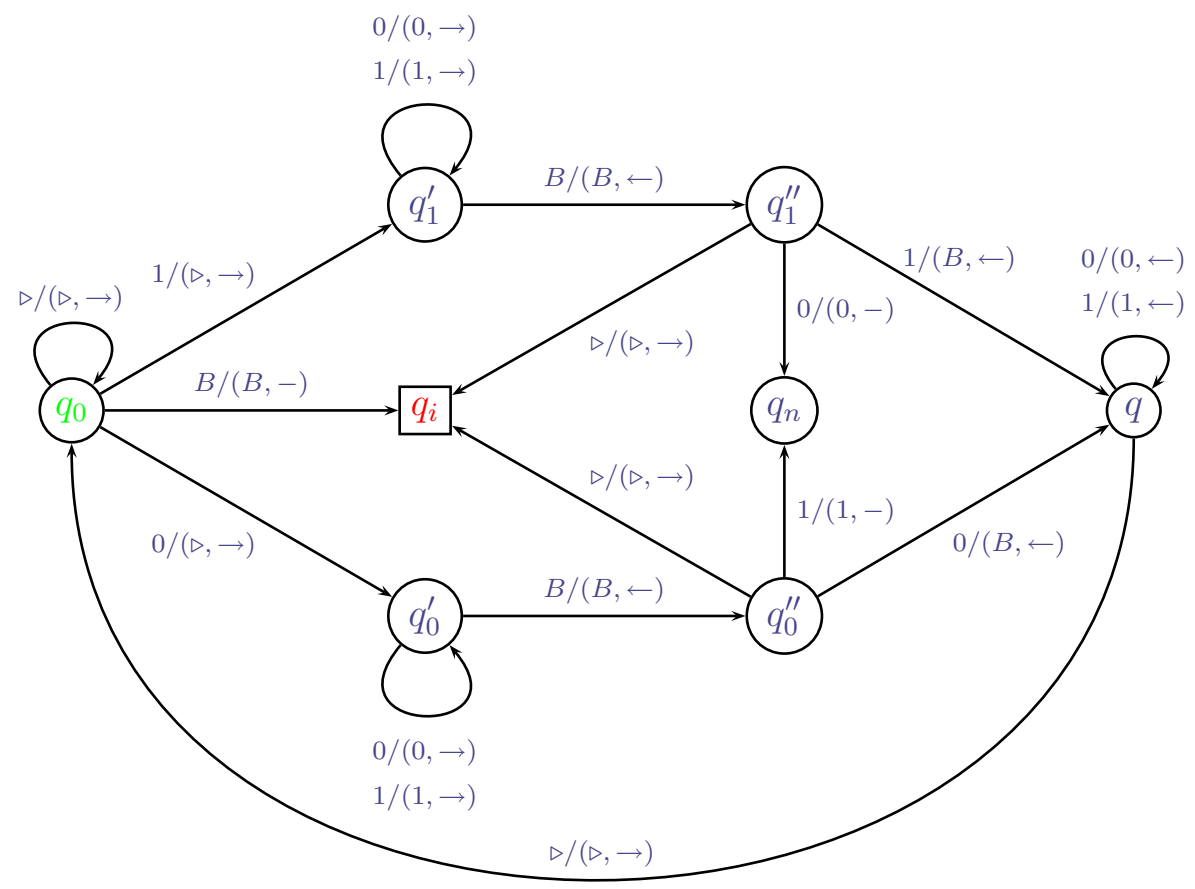

# A palindromákat eldöntő Turing-gép

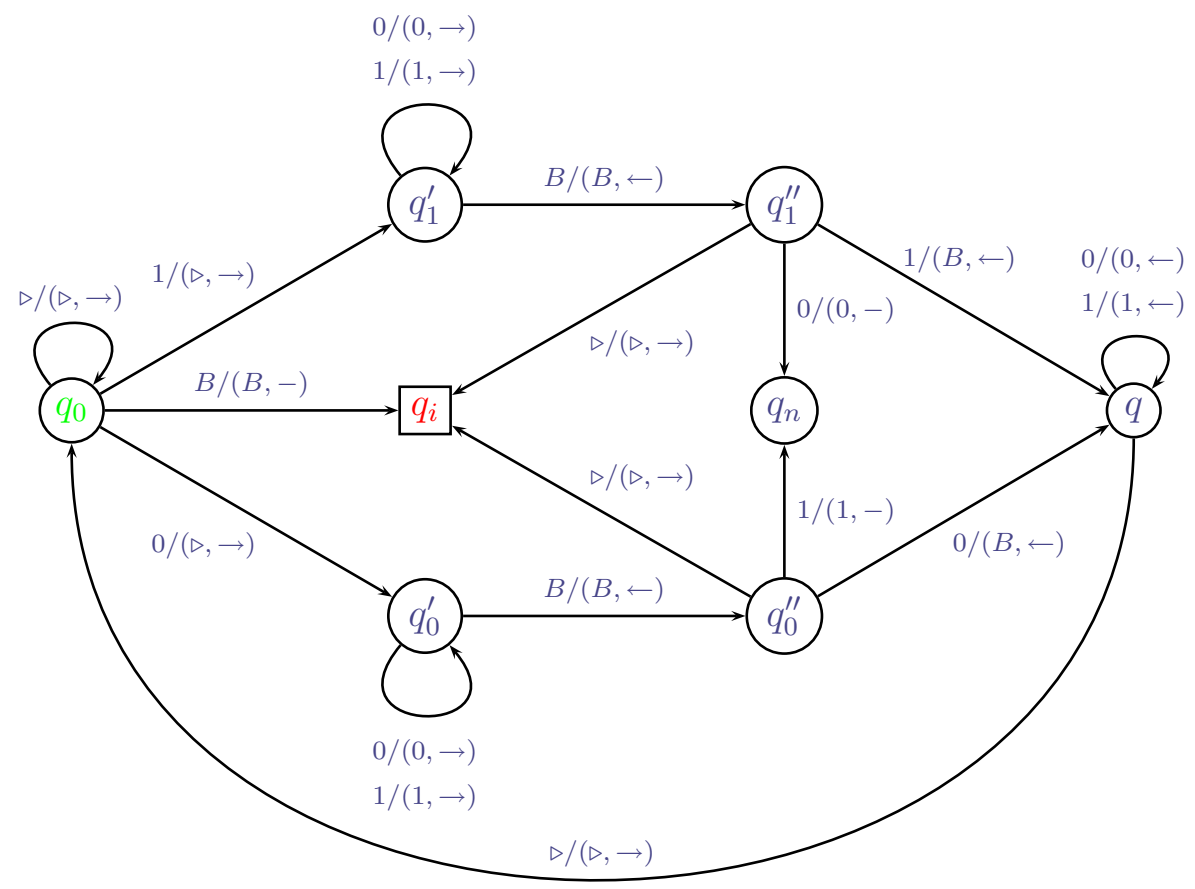
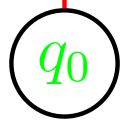

# A palindromákat eldöntő Turing-gép

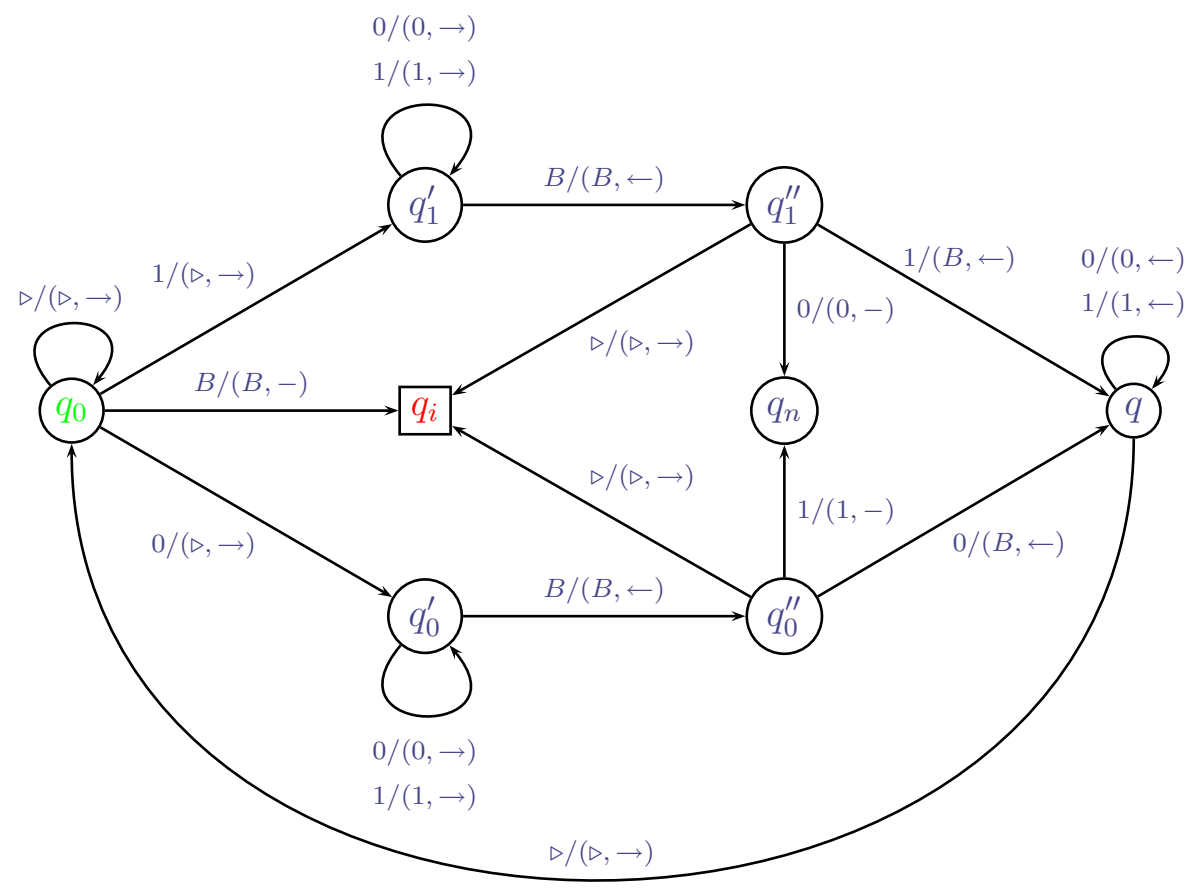
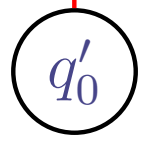
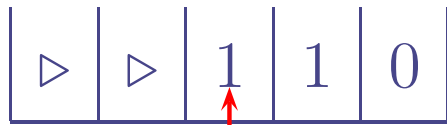

# A palindromákat eldöntő Turing-gép

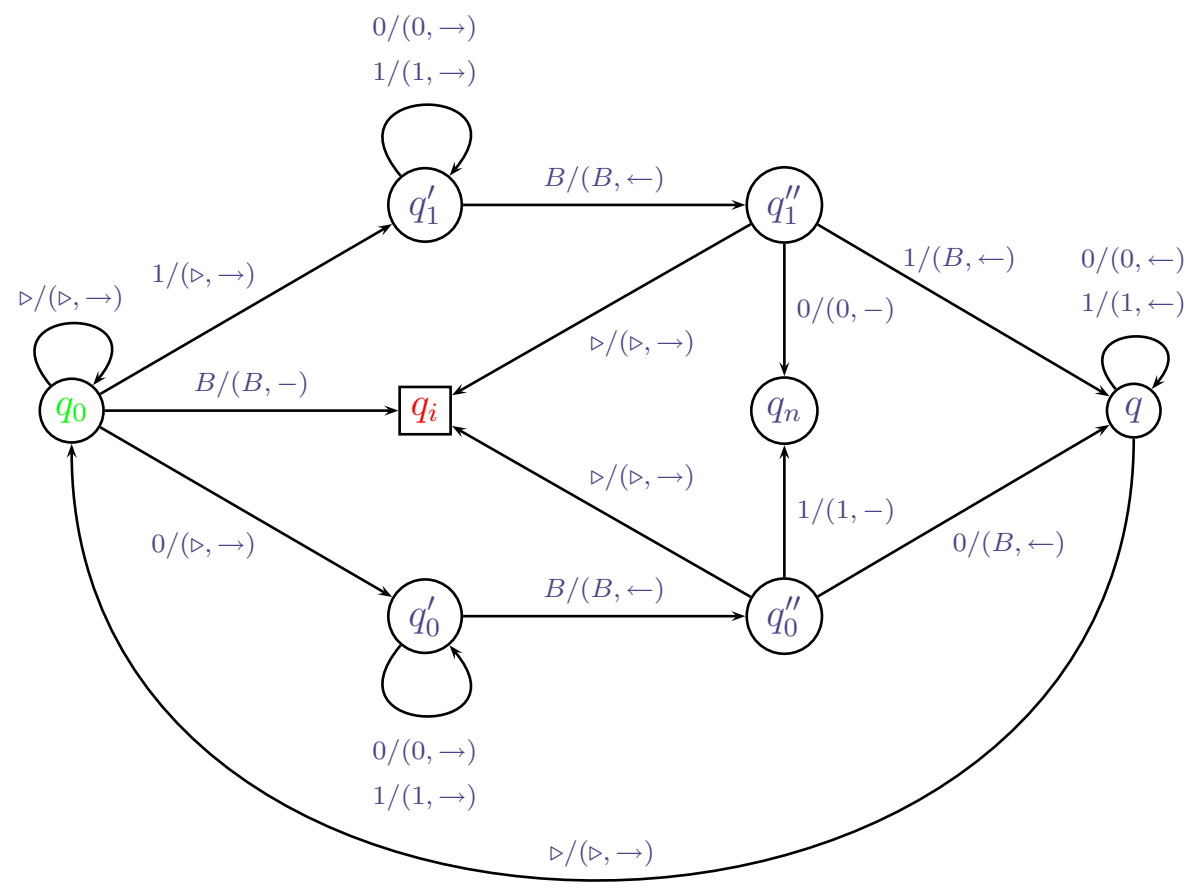
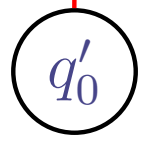

# A palindromákat eldöntő Turing-gép

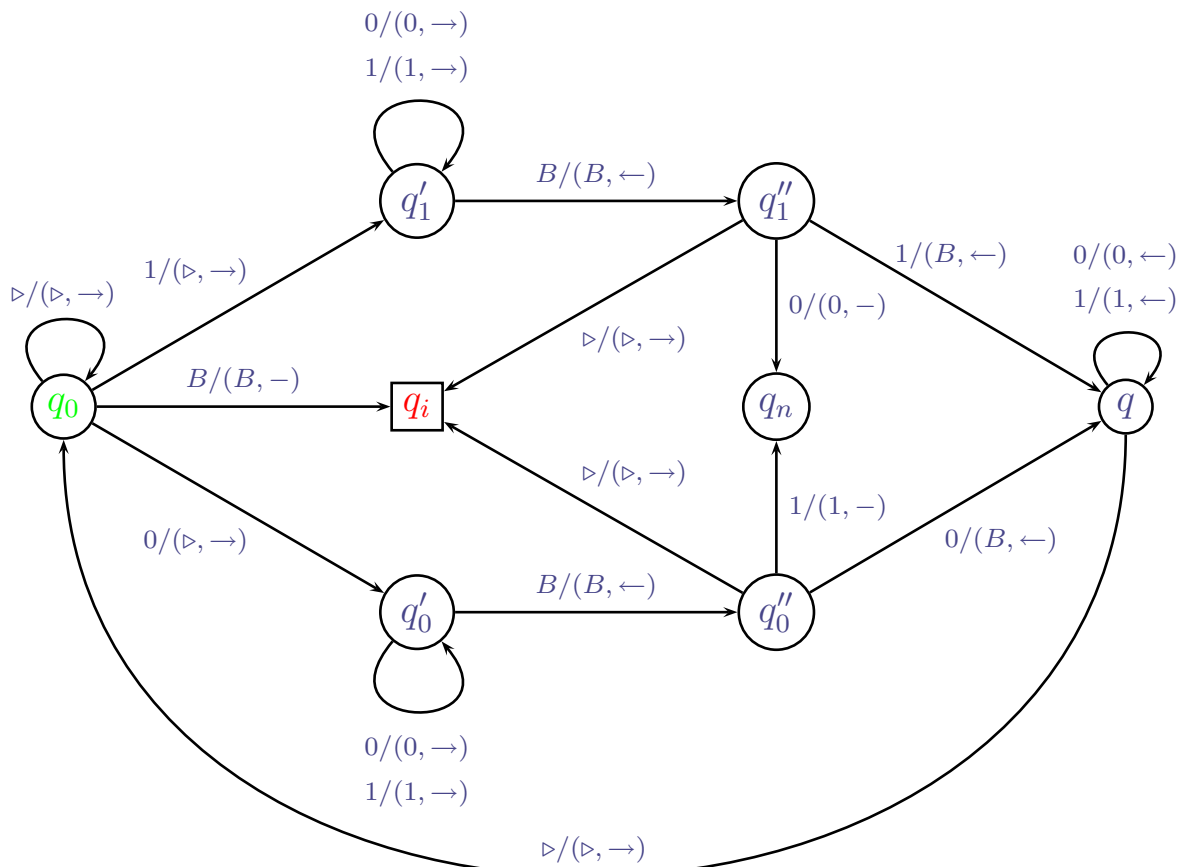
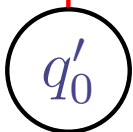

# A palindromákat eldöntő Turing-gép

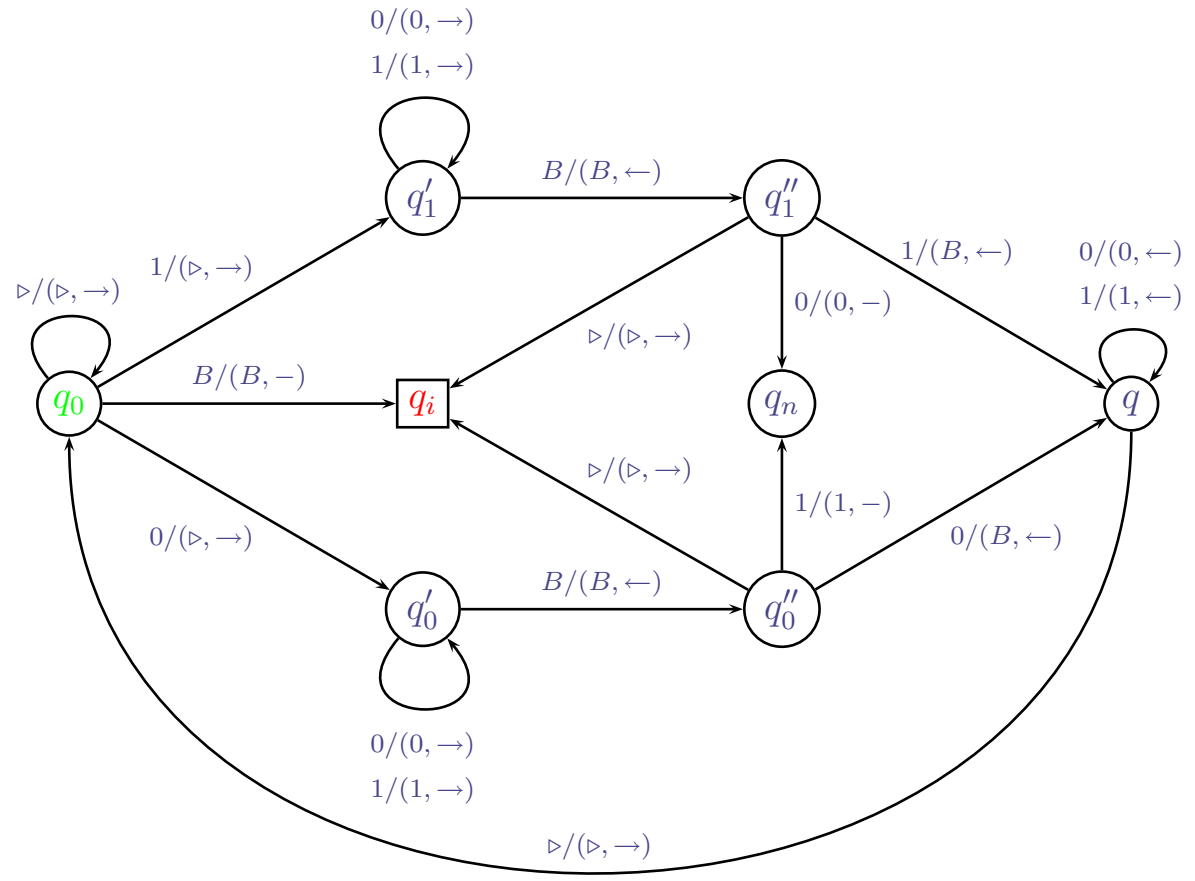
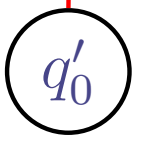
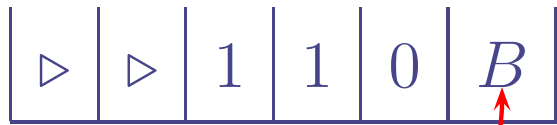



# A palindromákat eldöntő Turing-gép

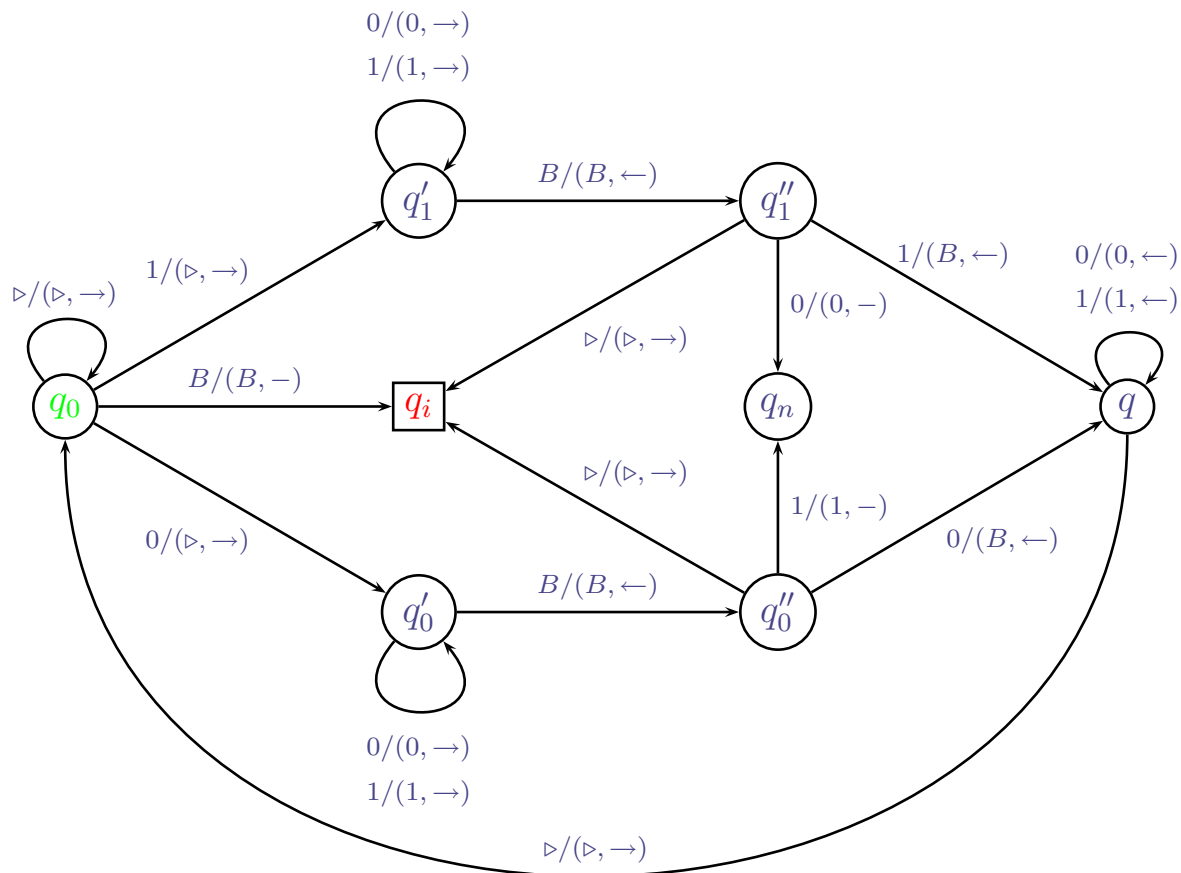
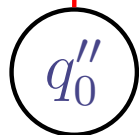

# A palindromákat eldöntő Turing-gép

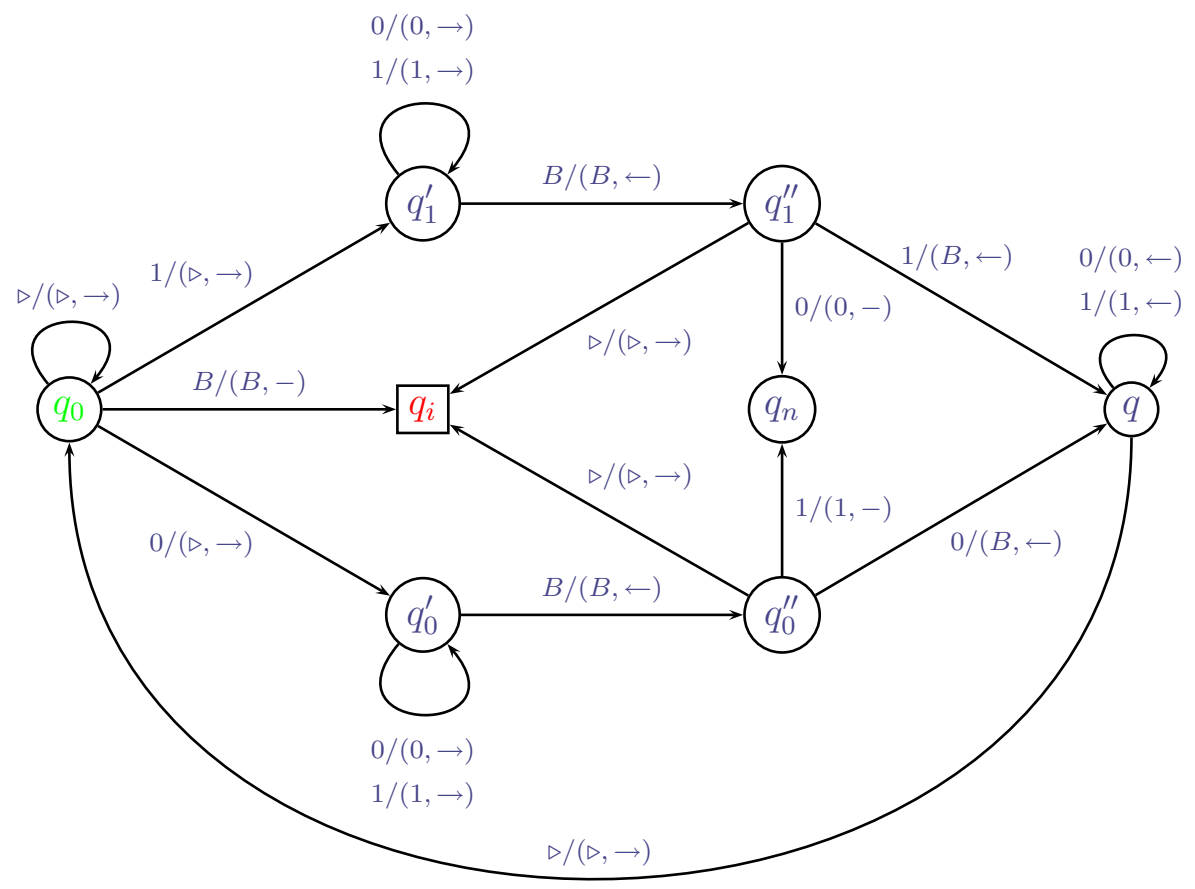
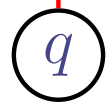
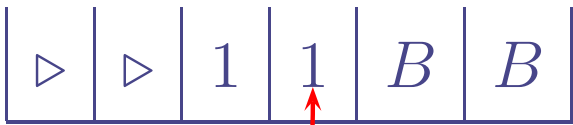

# A palindromákat eldöntő Turing-gép

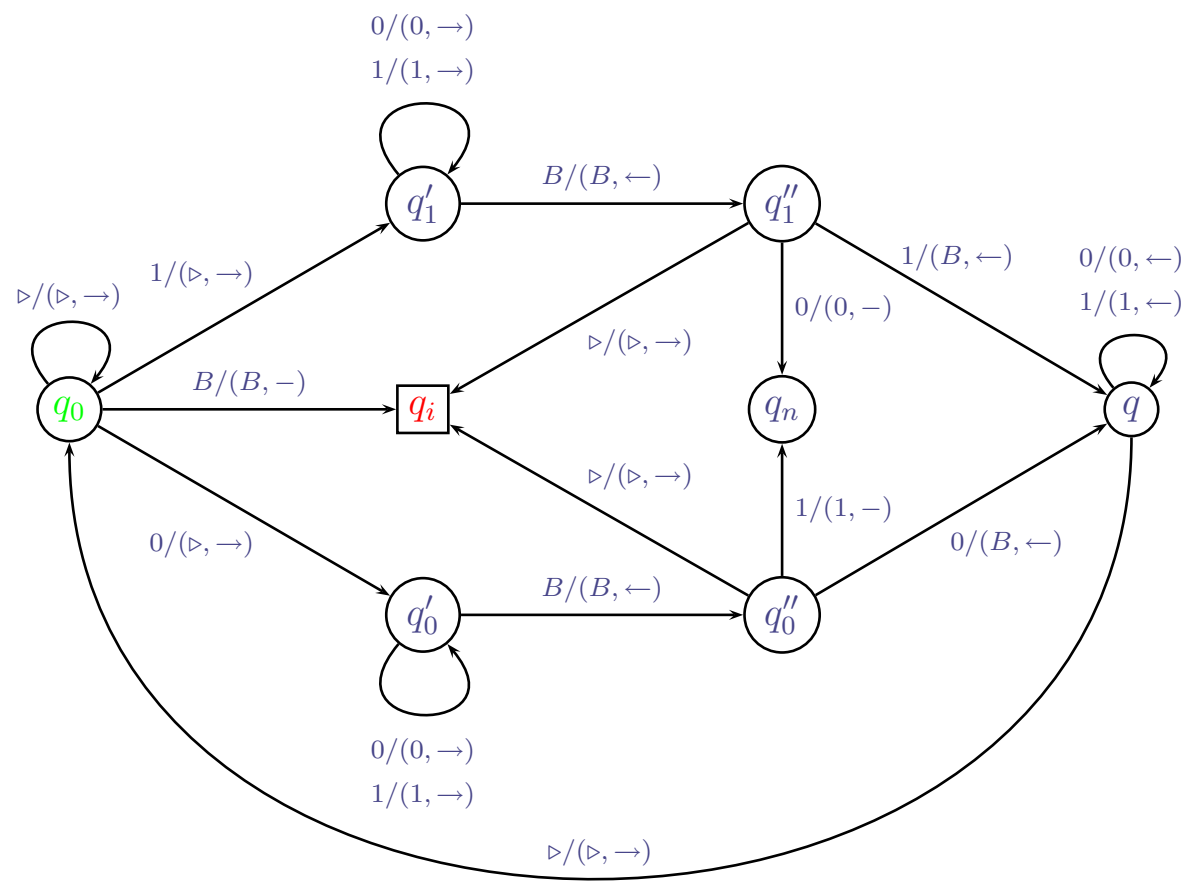
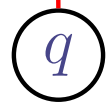
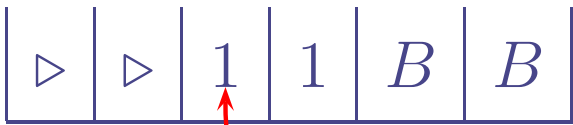

# A palindromákat eldöntő Turing-gép

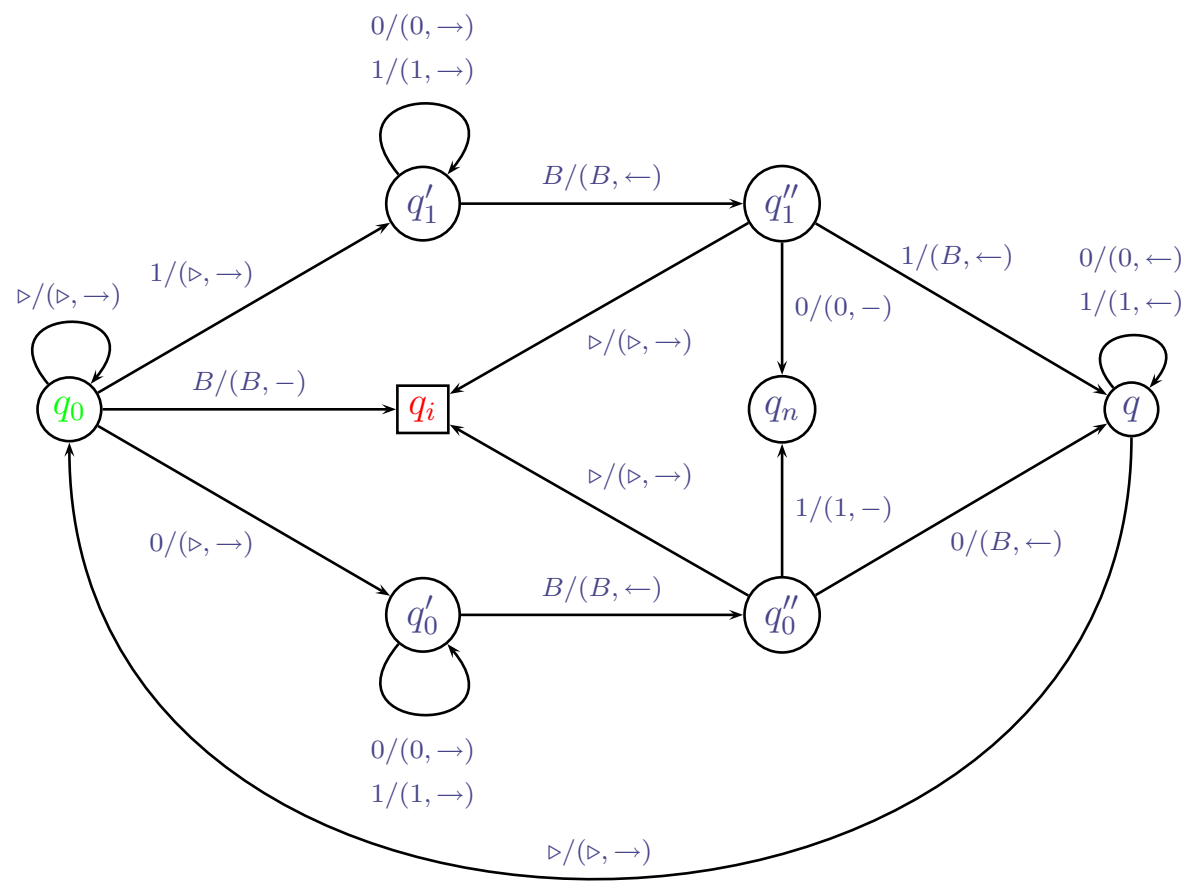
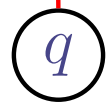

# A palindromákat eldöntő Turing-gép

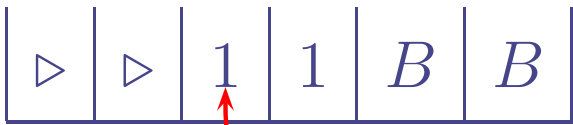

$q_0$

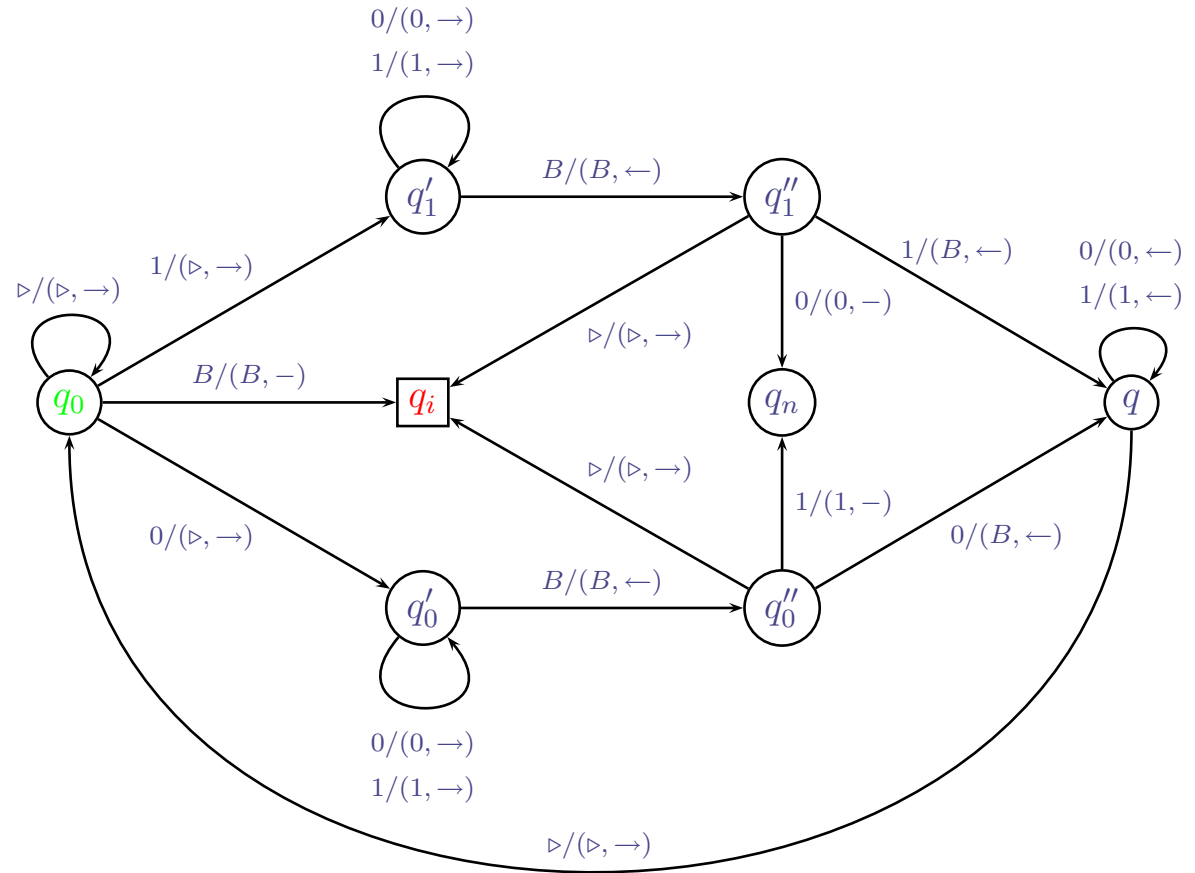

# A palindromákat eldöntő Turing-gép

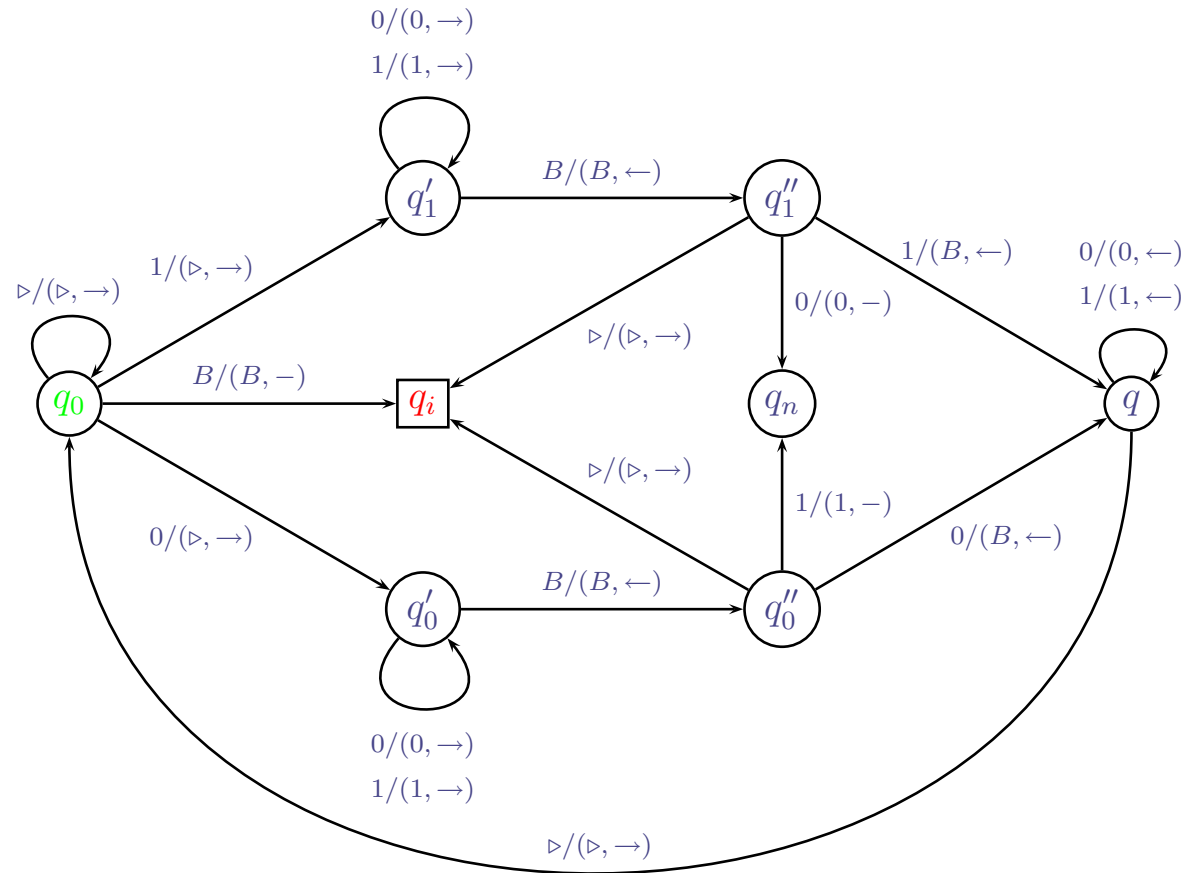
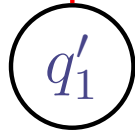
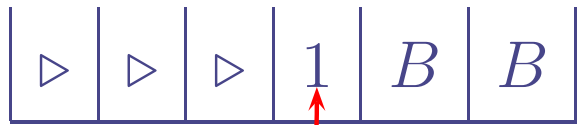

# A palindromákat eldöntő Turing-gép

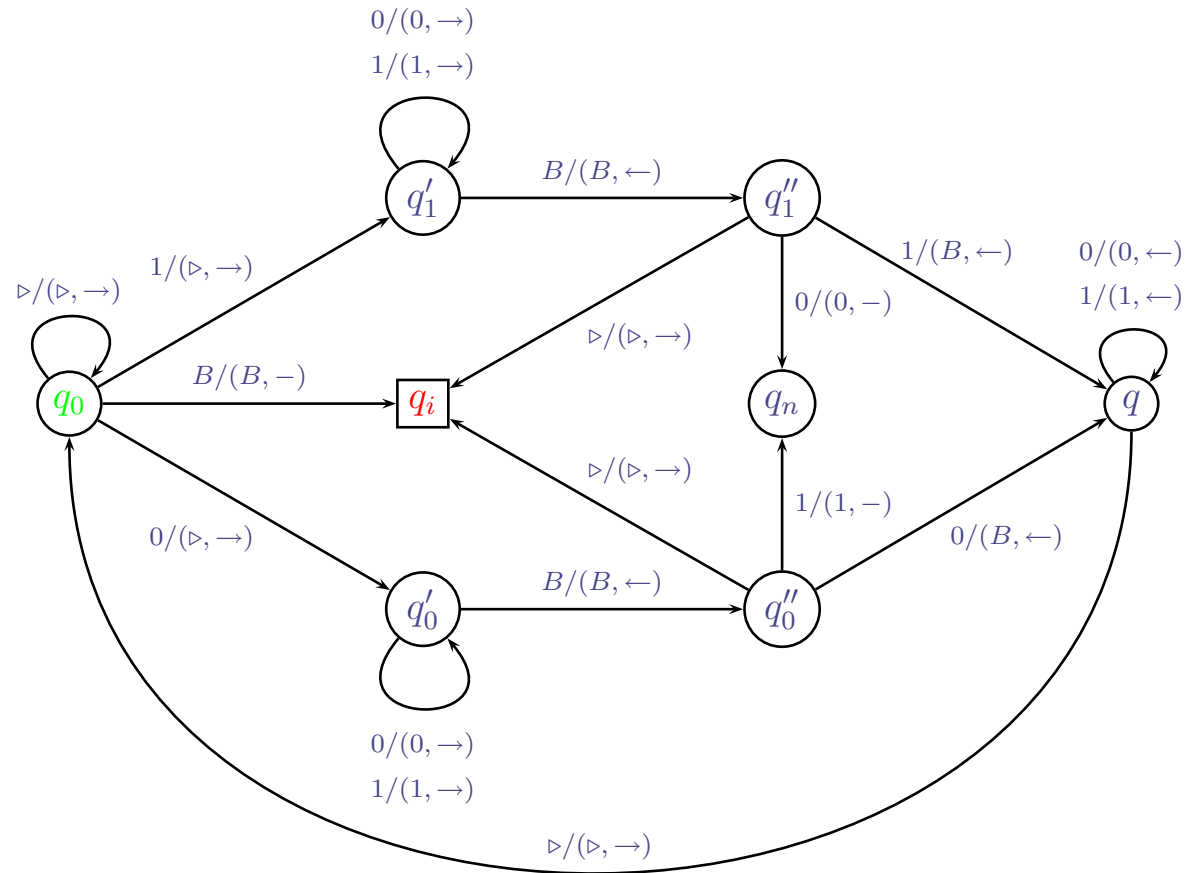
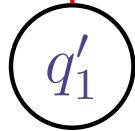
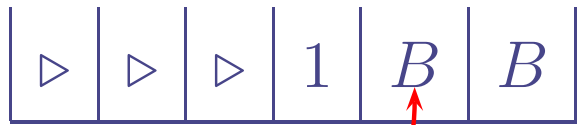

# A palindromákat eldöntő Turing-gép

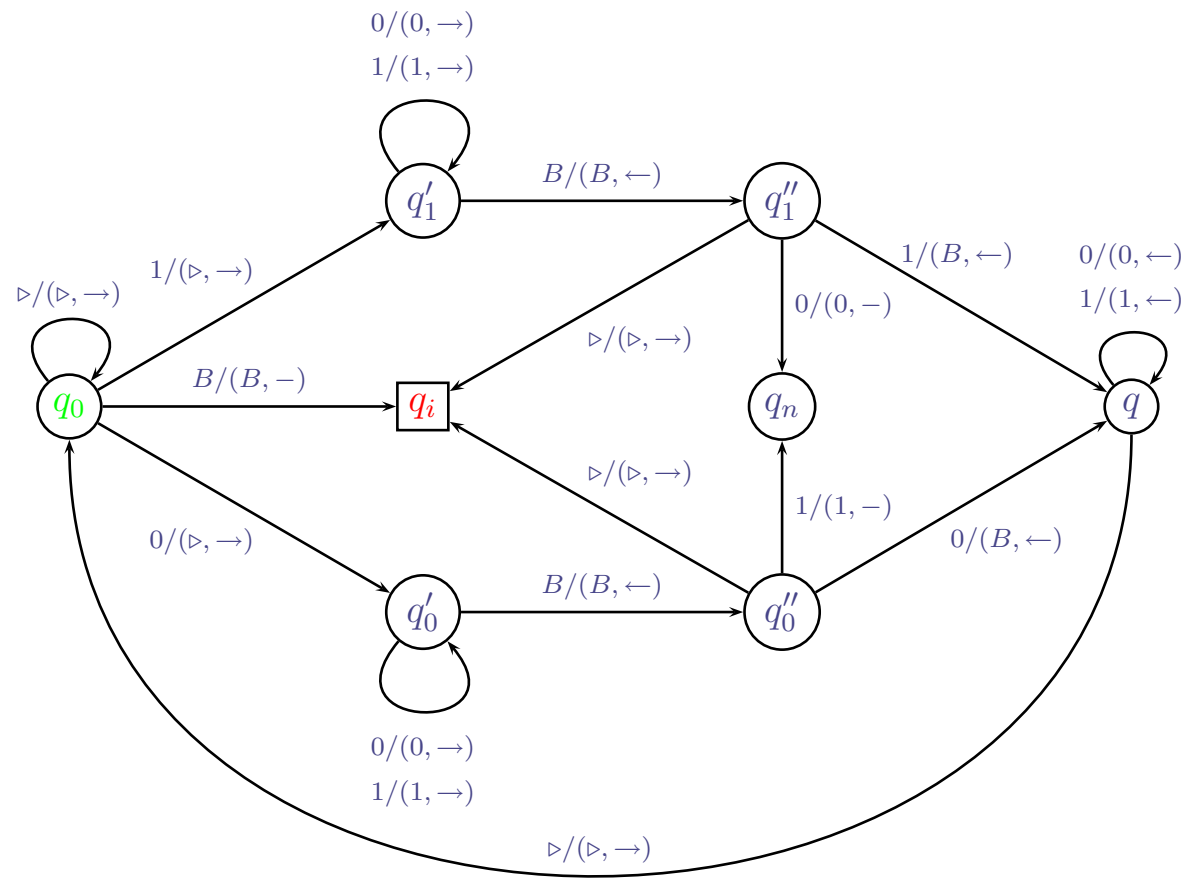
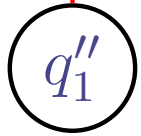
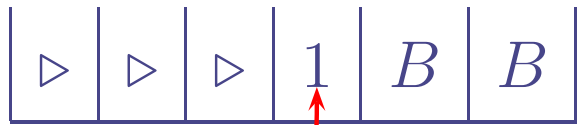



# A palindromákat eldöntő Turing-gép

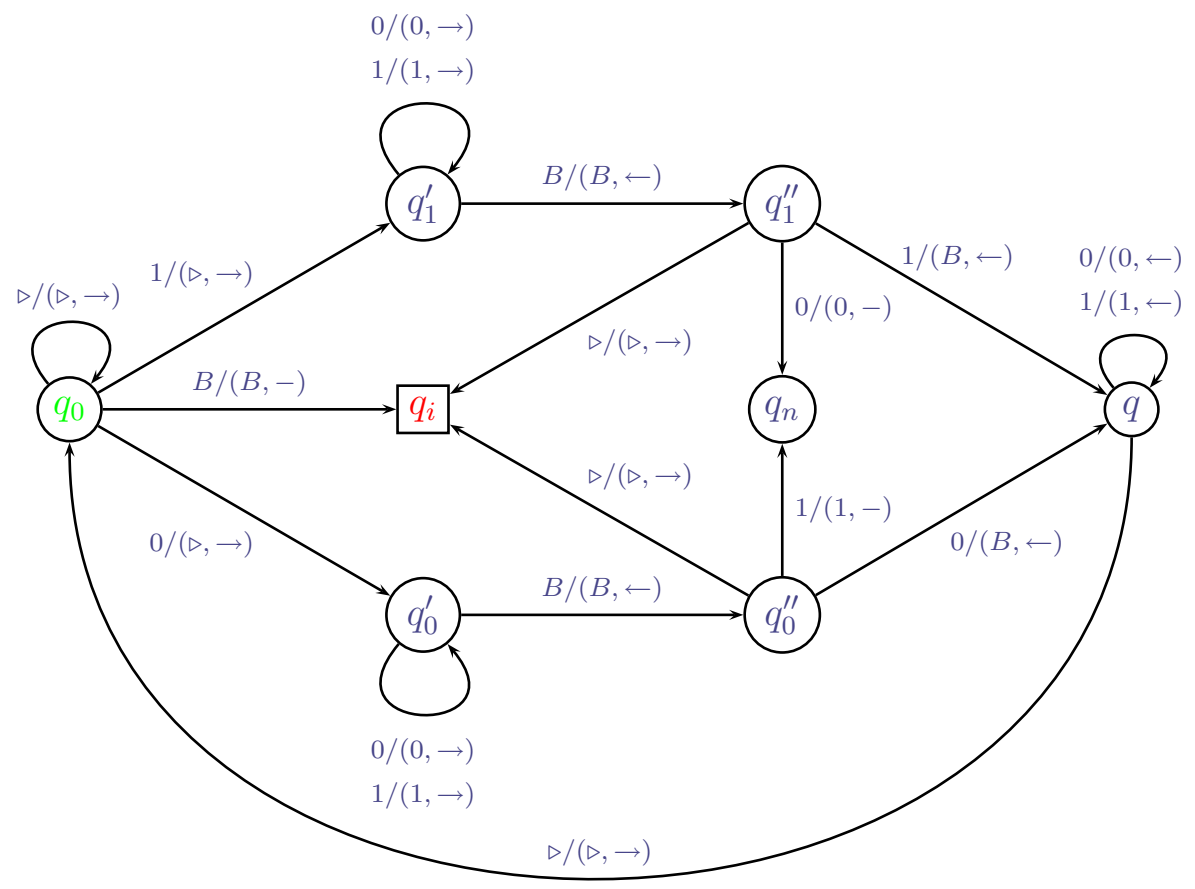
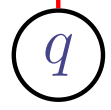
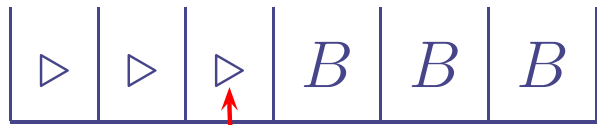

# A palindromákat eldöntő Turing-gép

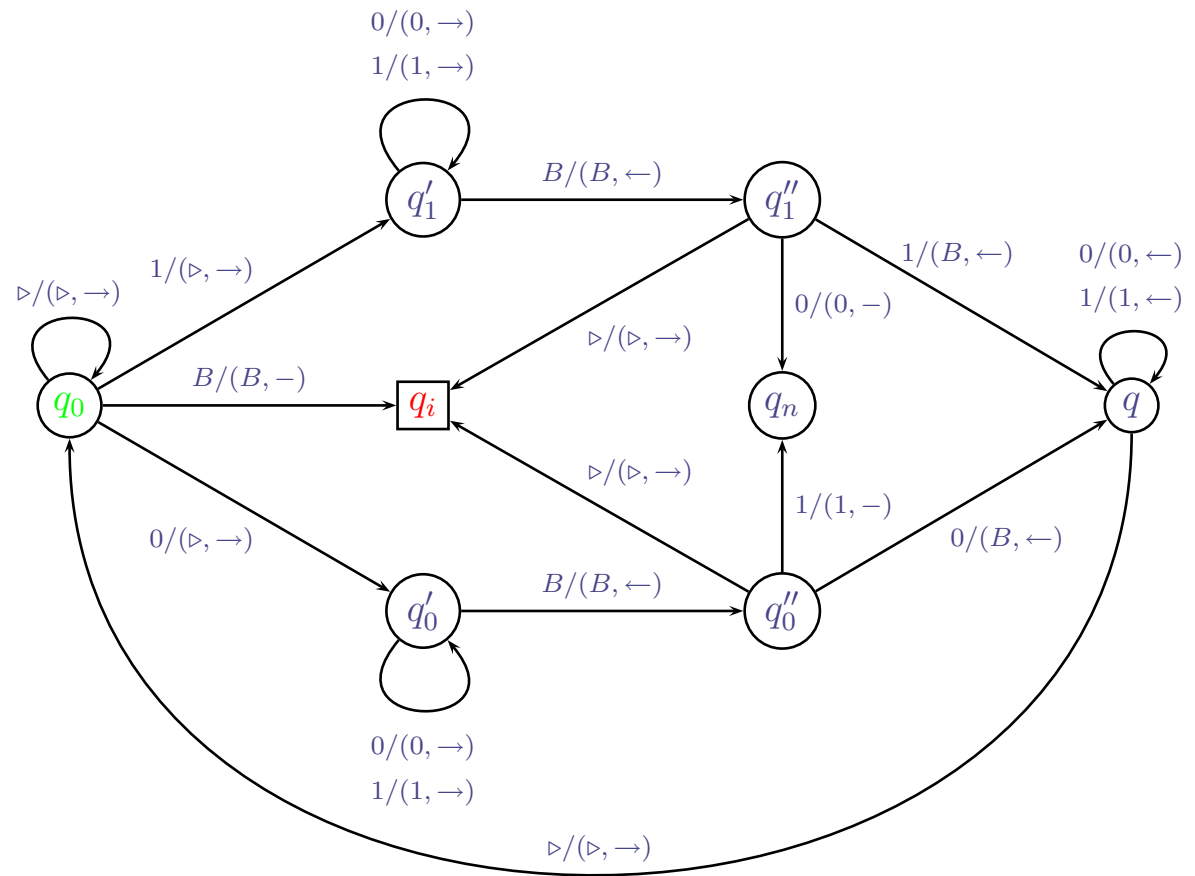
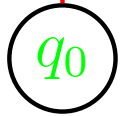
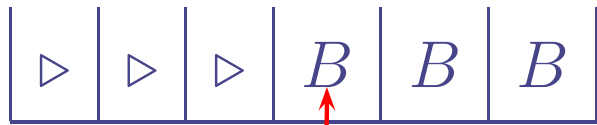

# A palindromákat eldöntő Turing-gép

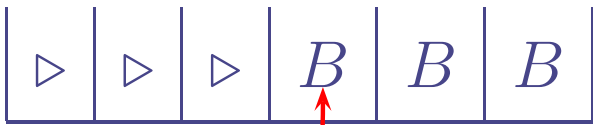

$q_i$

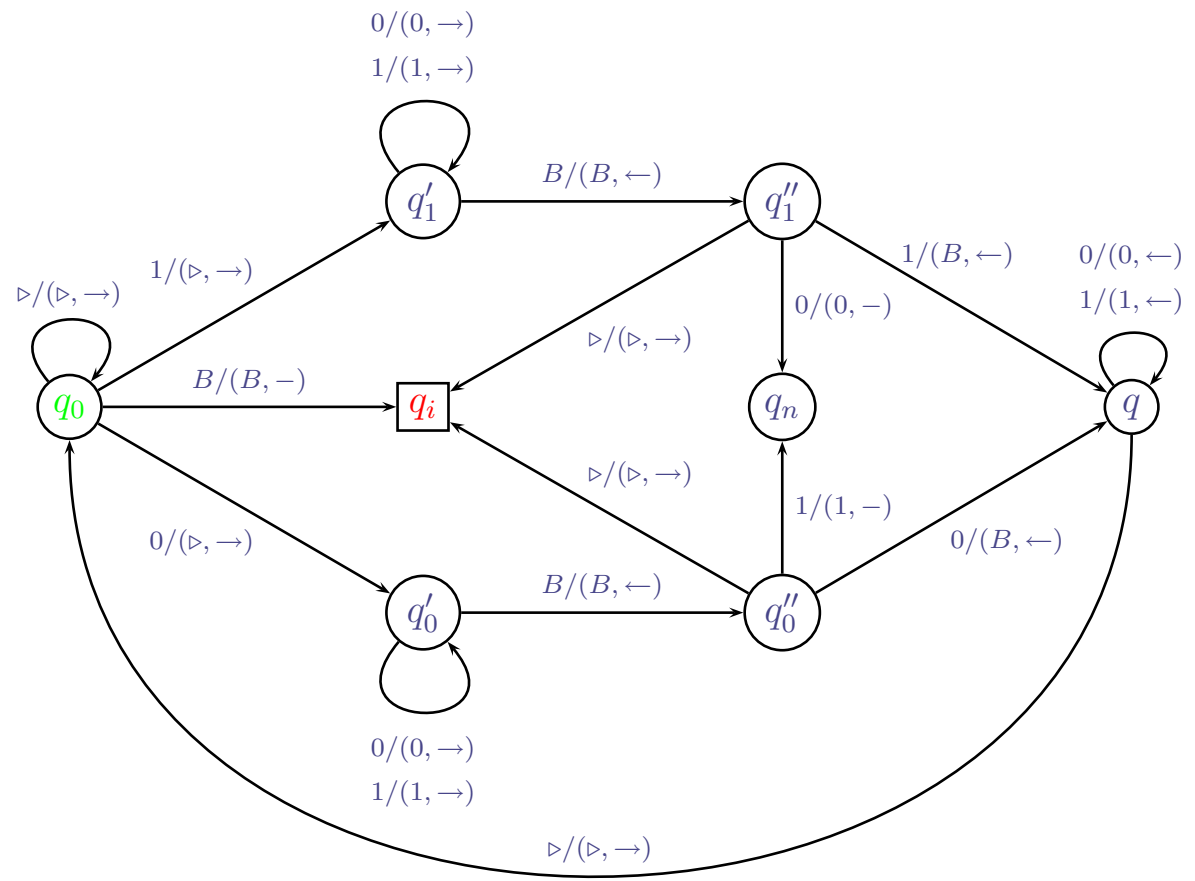

# A palindromákat eldöntő Turing-gép

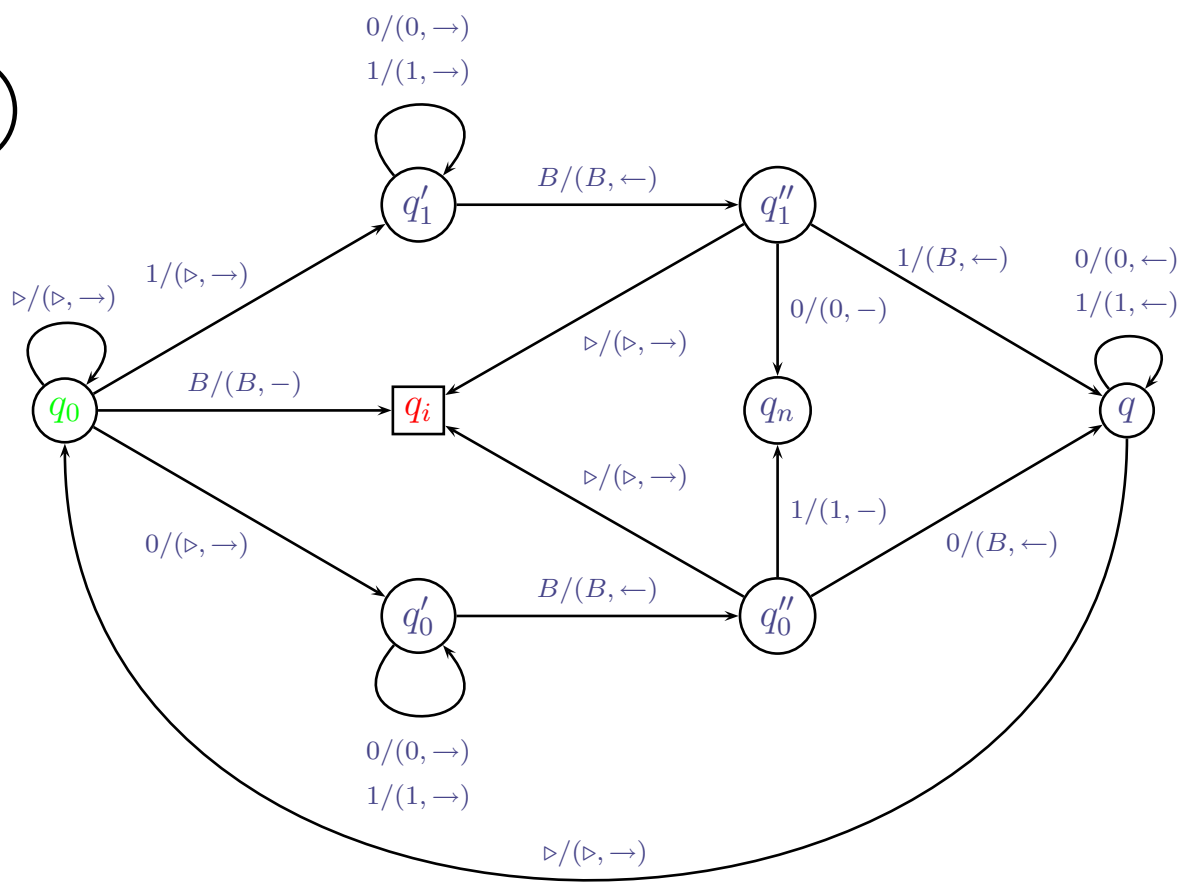
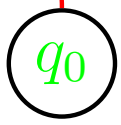

# A palindromákat eldöntő Turing-gép

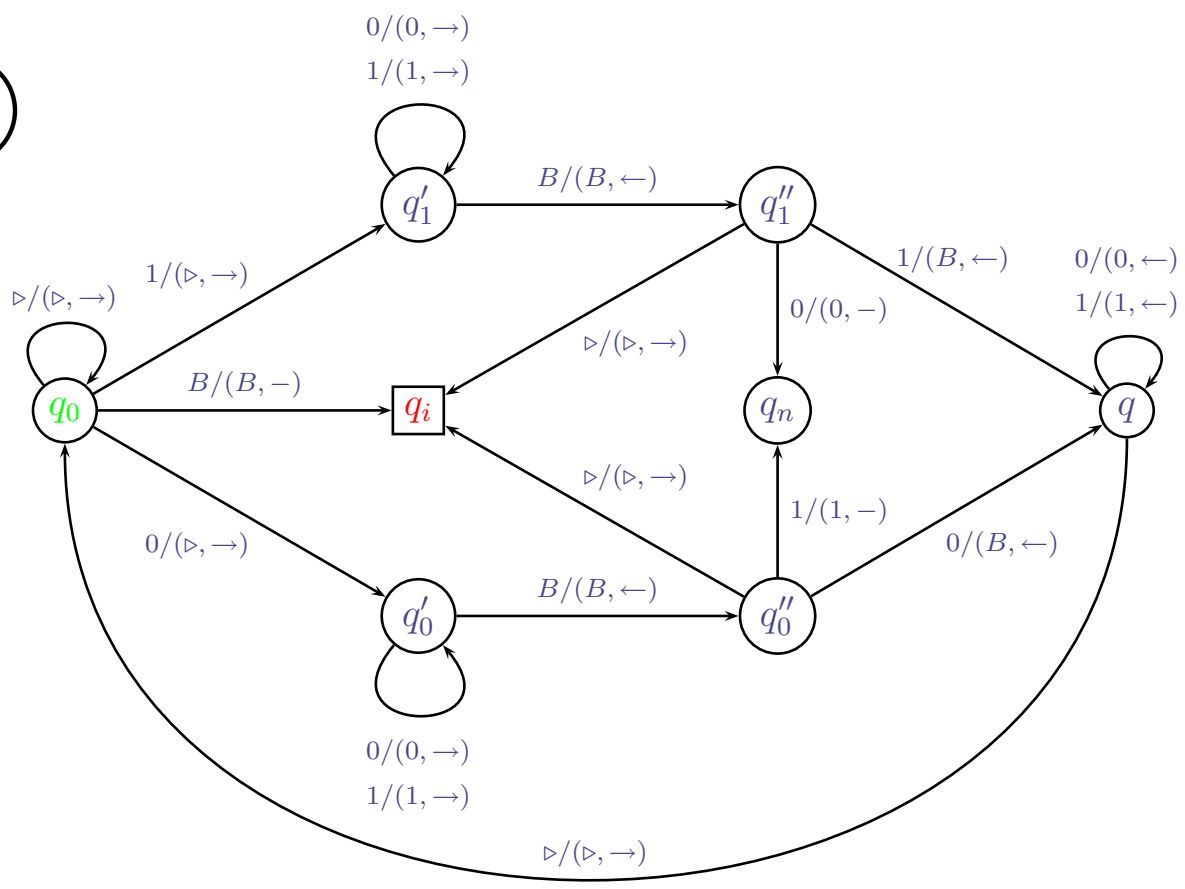
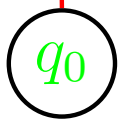

# A palindromákat eldöntő Turing-gép

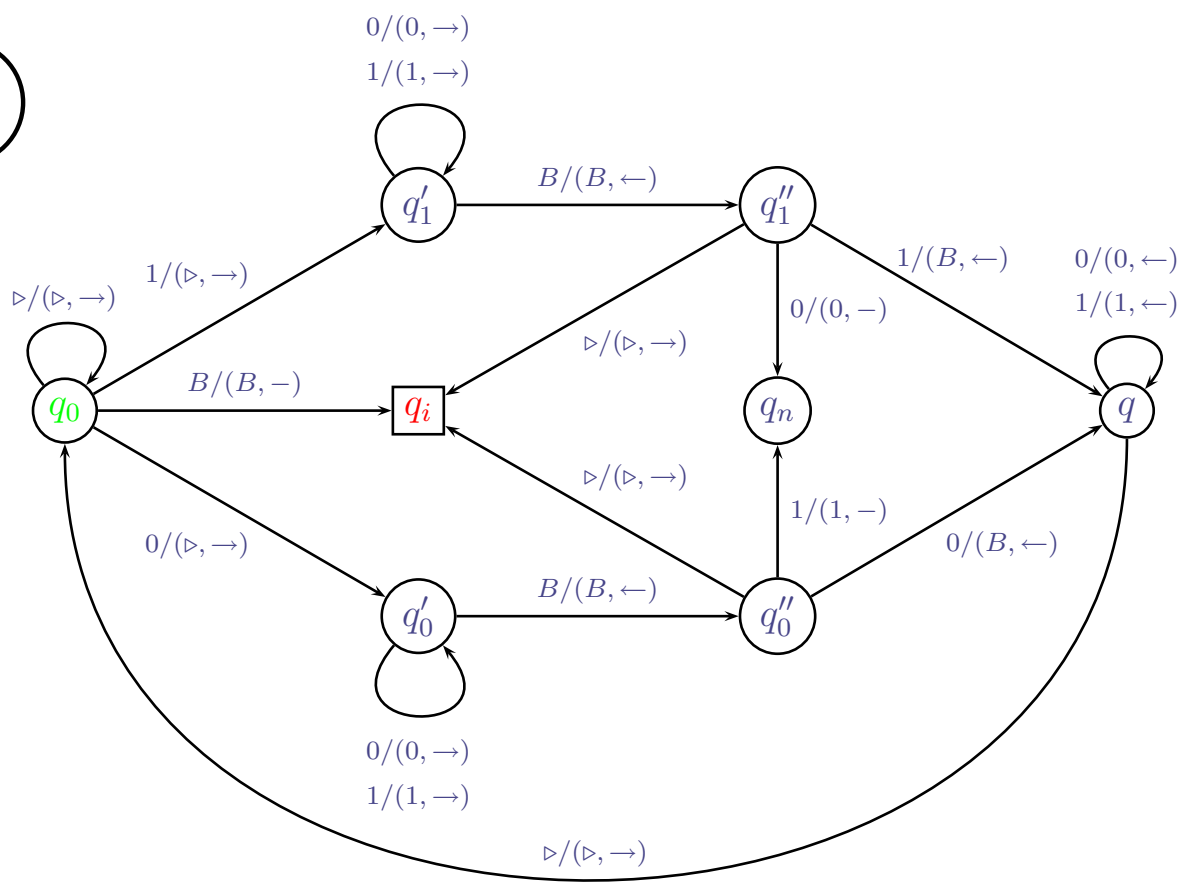
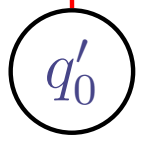

# A palindromákat eldöntő Turing-gép

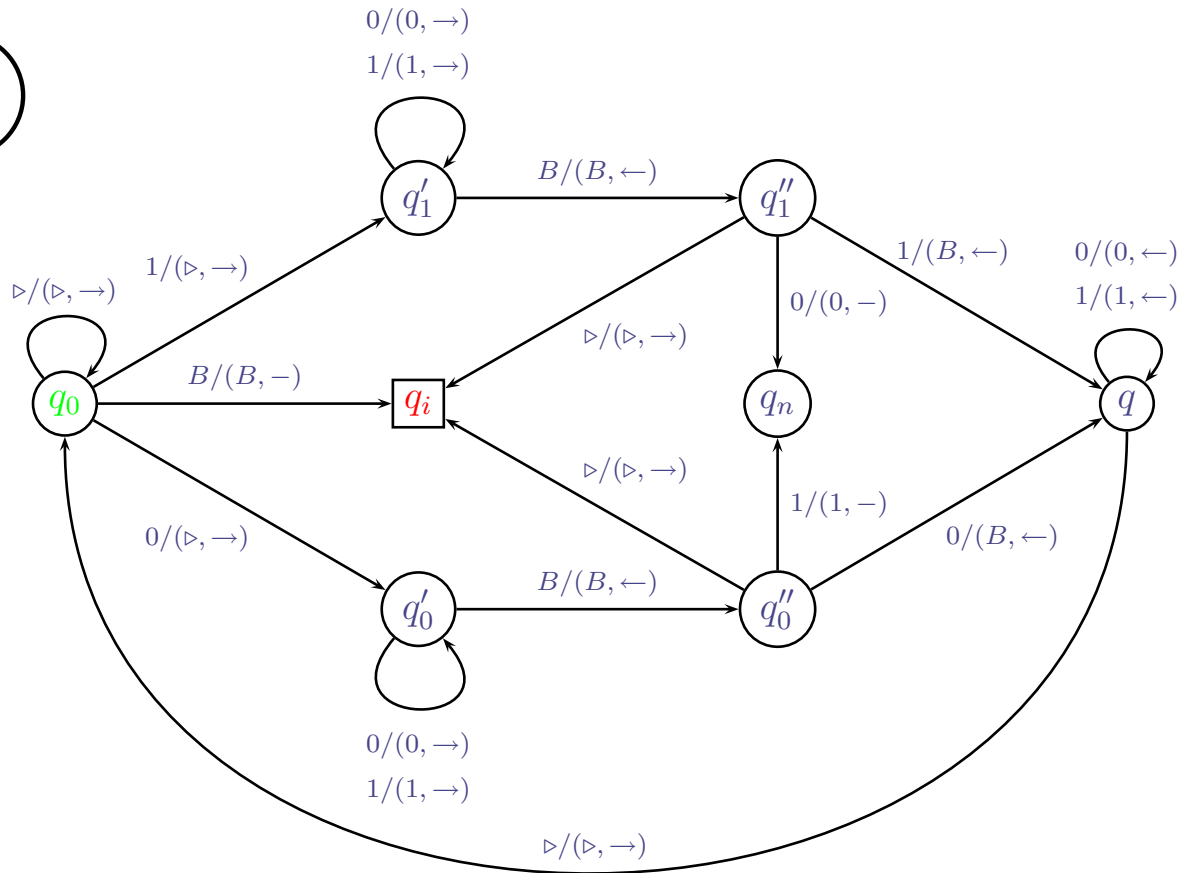
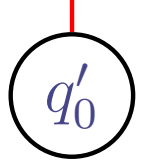
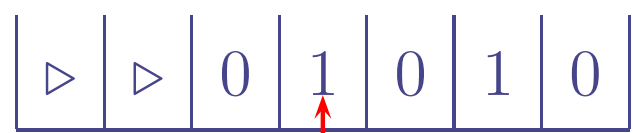

# A palindromákat eldöntő Turing-gép

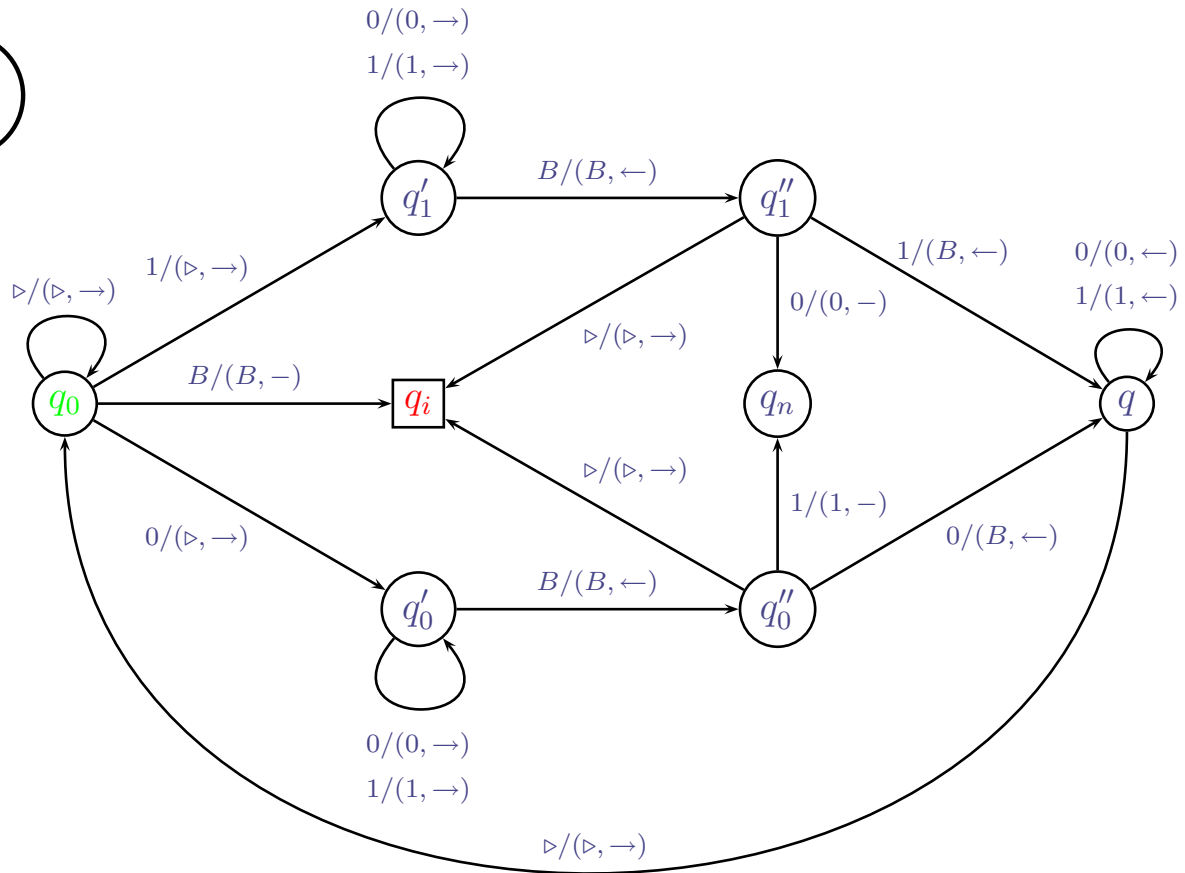
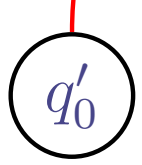



# A palindromákat eldöntő Turing-gép

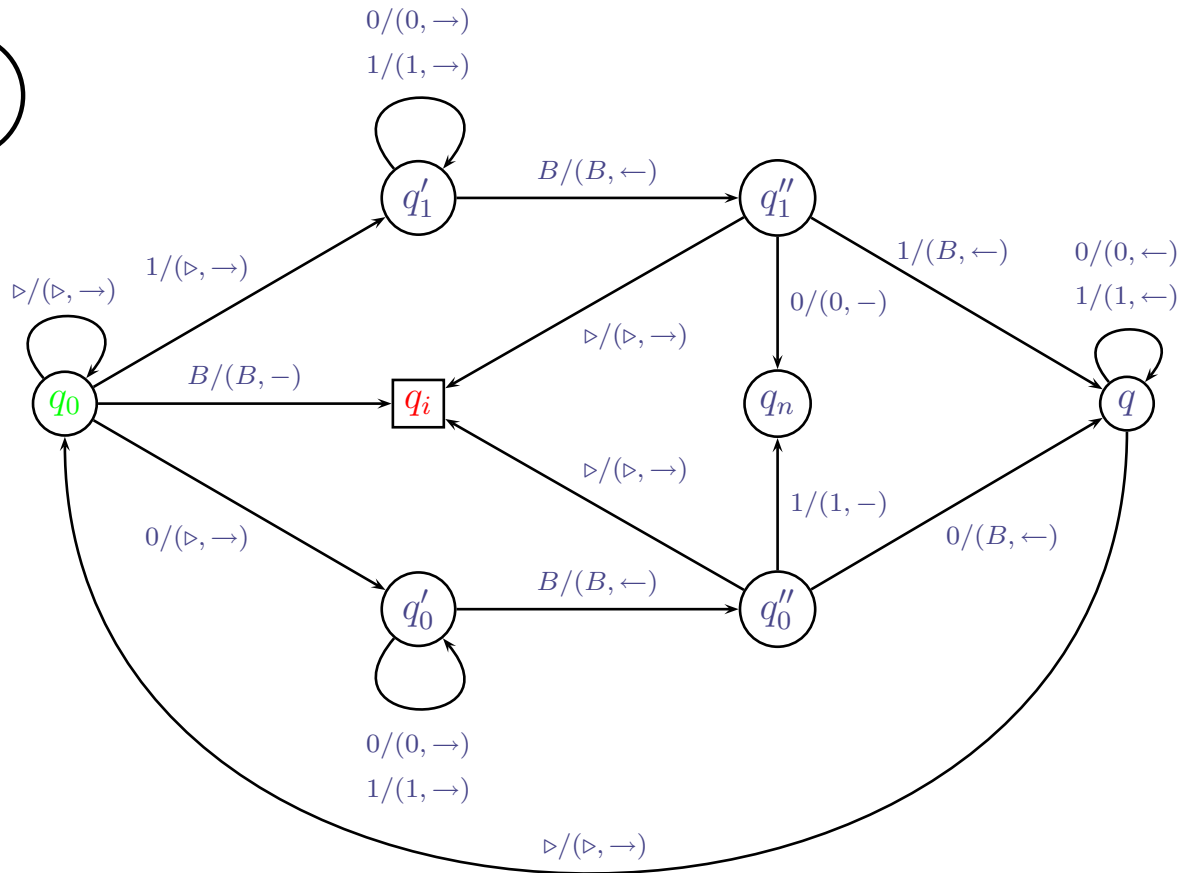
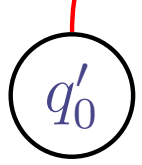

# A palindromákat eldöntő Turing-gép

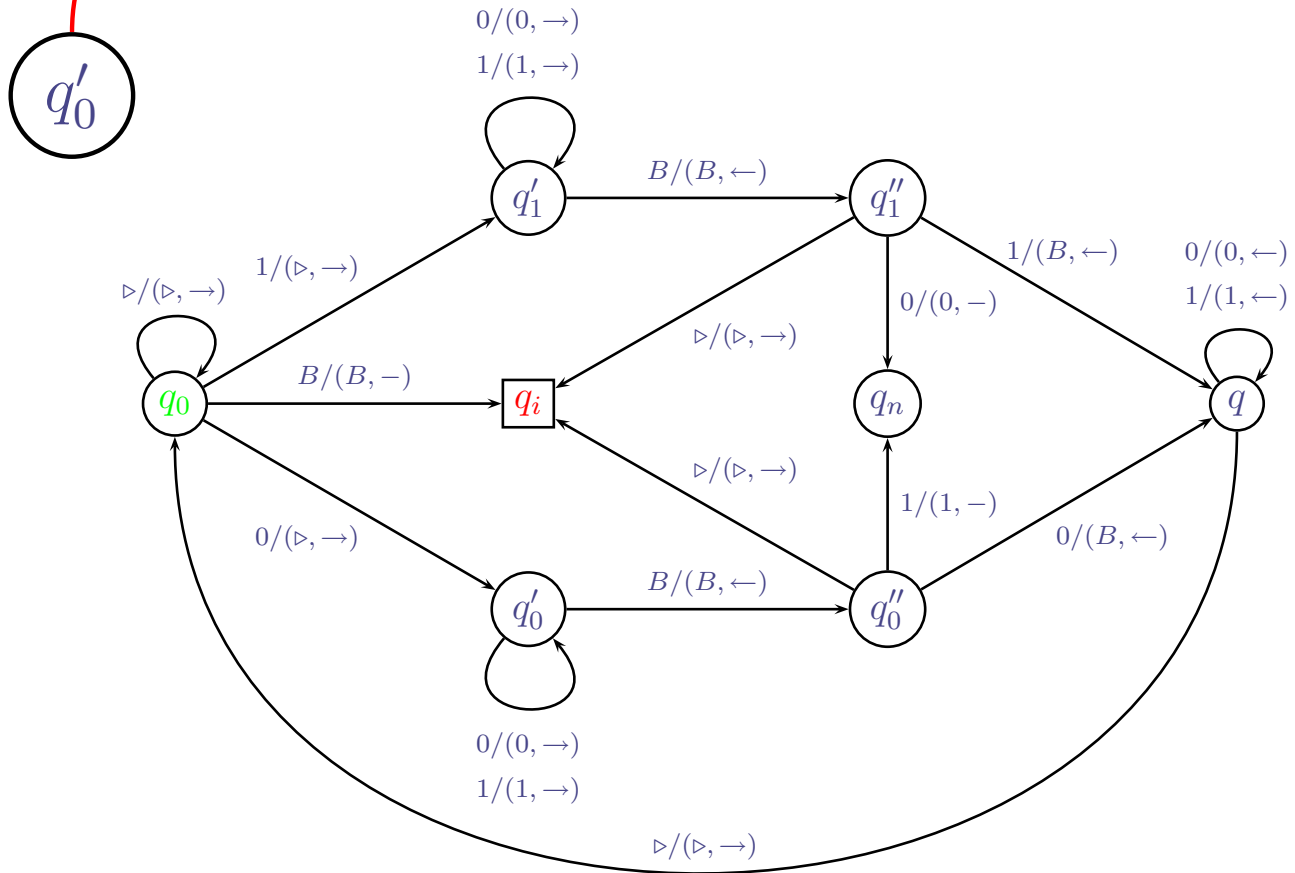

# A palindromákat eldöntő Turing-gép

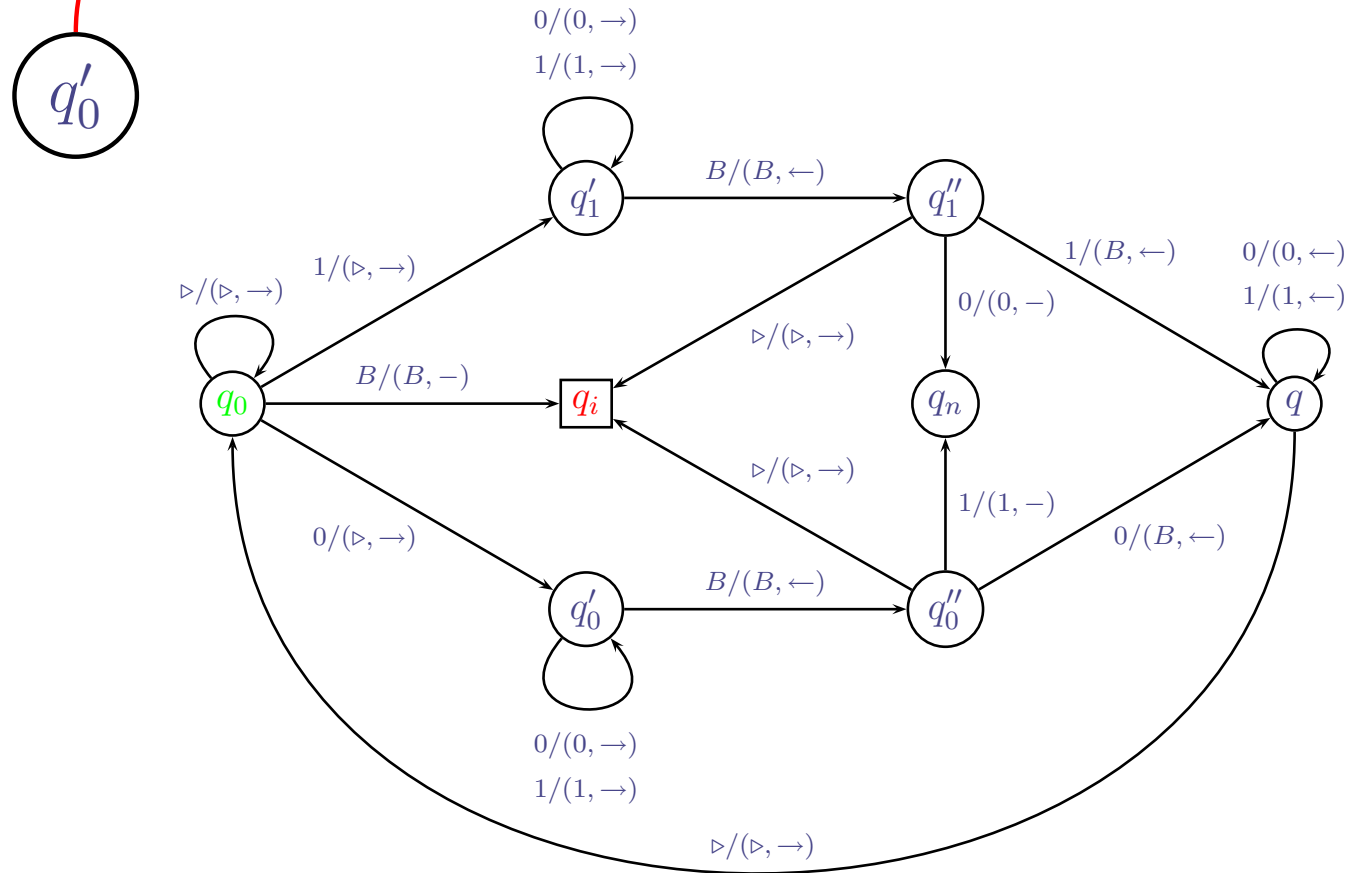

# A palindromákat eldöntő Turing-gép

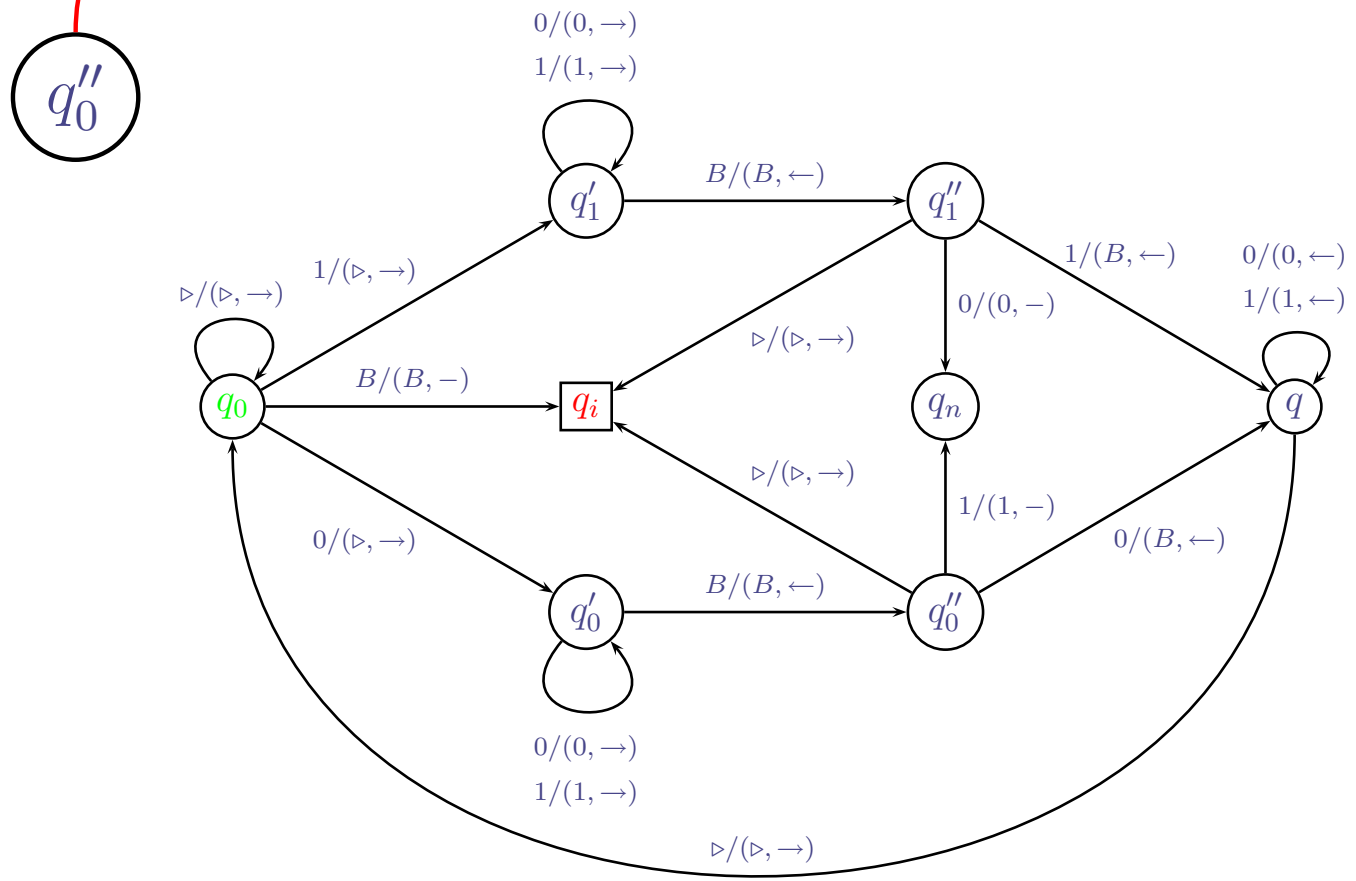

# A palindromákat eldöntő Turing-gép

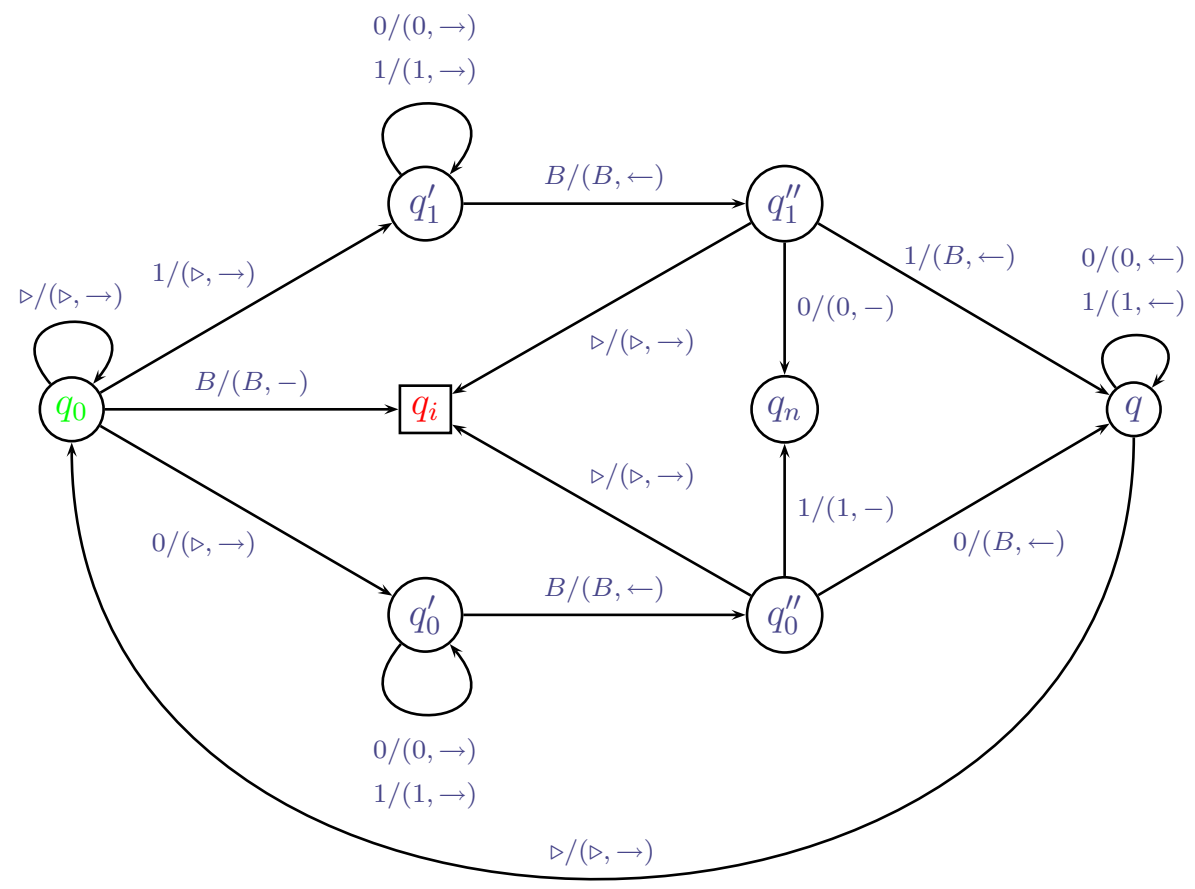
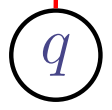

# A palindromákat eldöntő Turing-gép

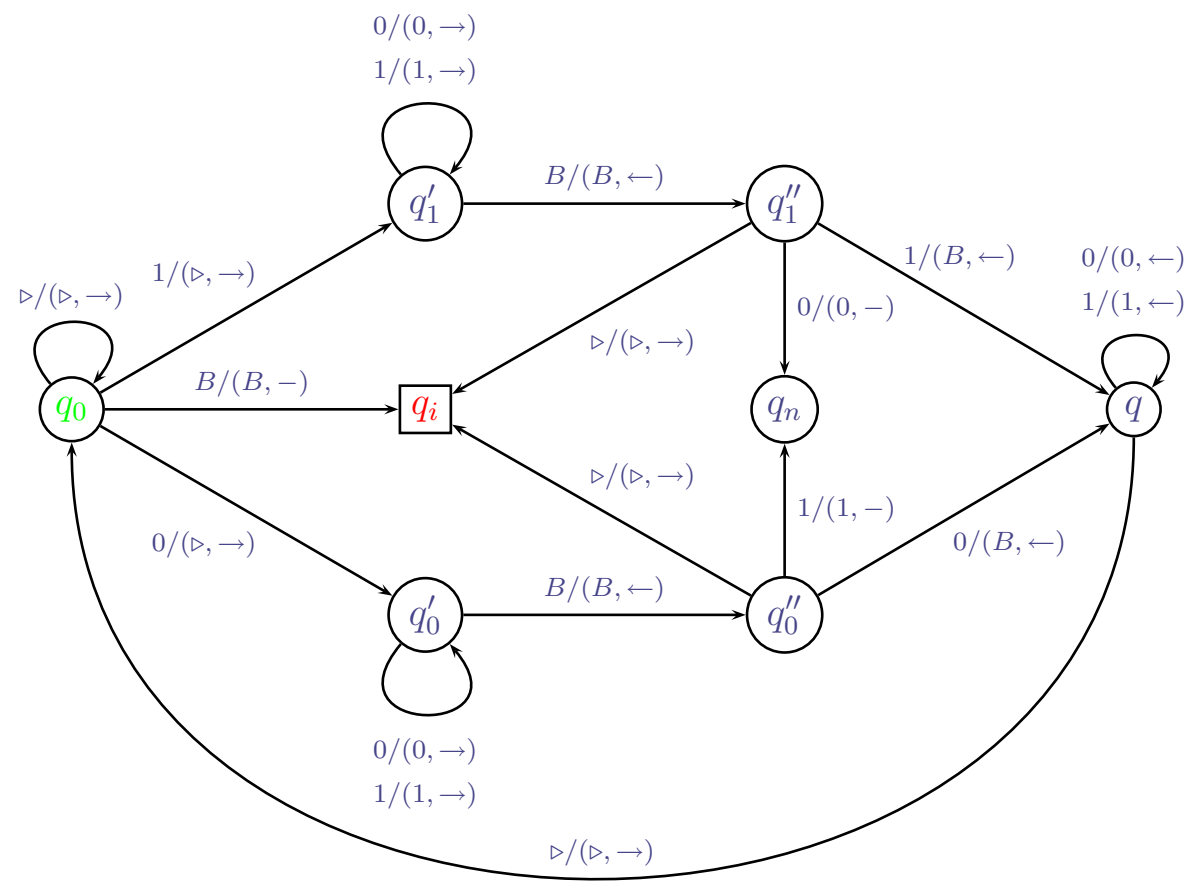
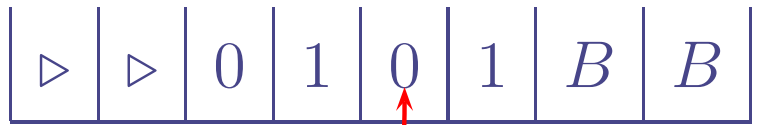

# A palindromákat eldöntő Turing-gép

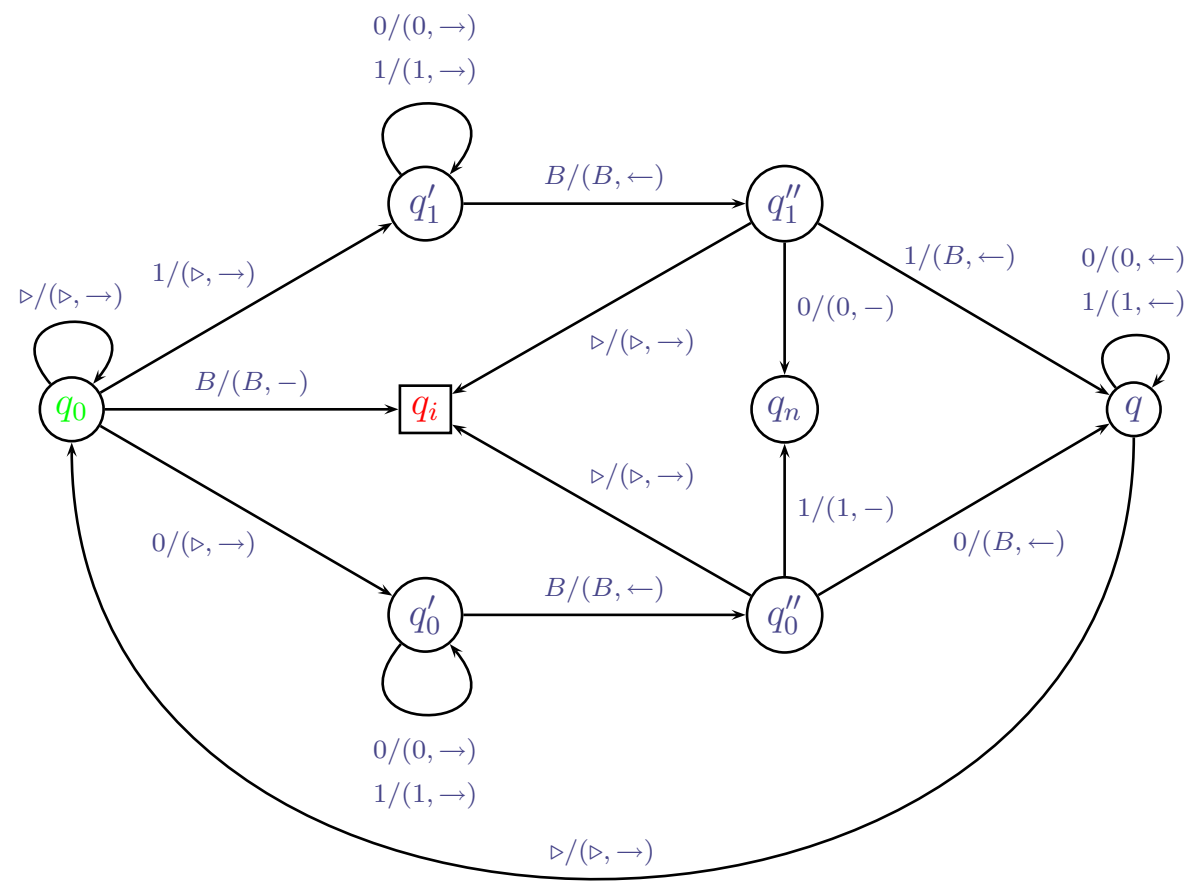
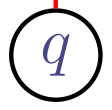

# A palindromákat eldöntő Turing-gép

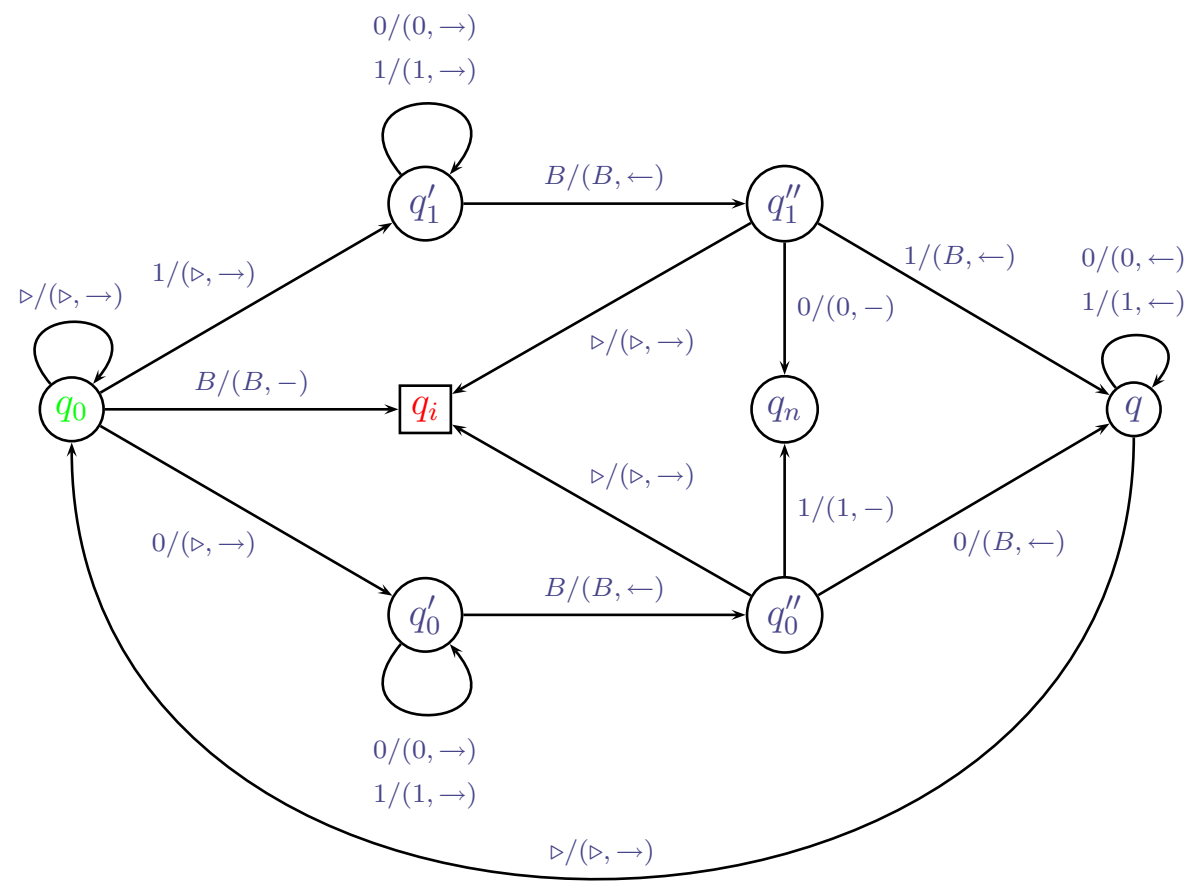
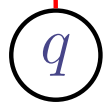



# A palindromákat eldöntő Turing-gép

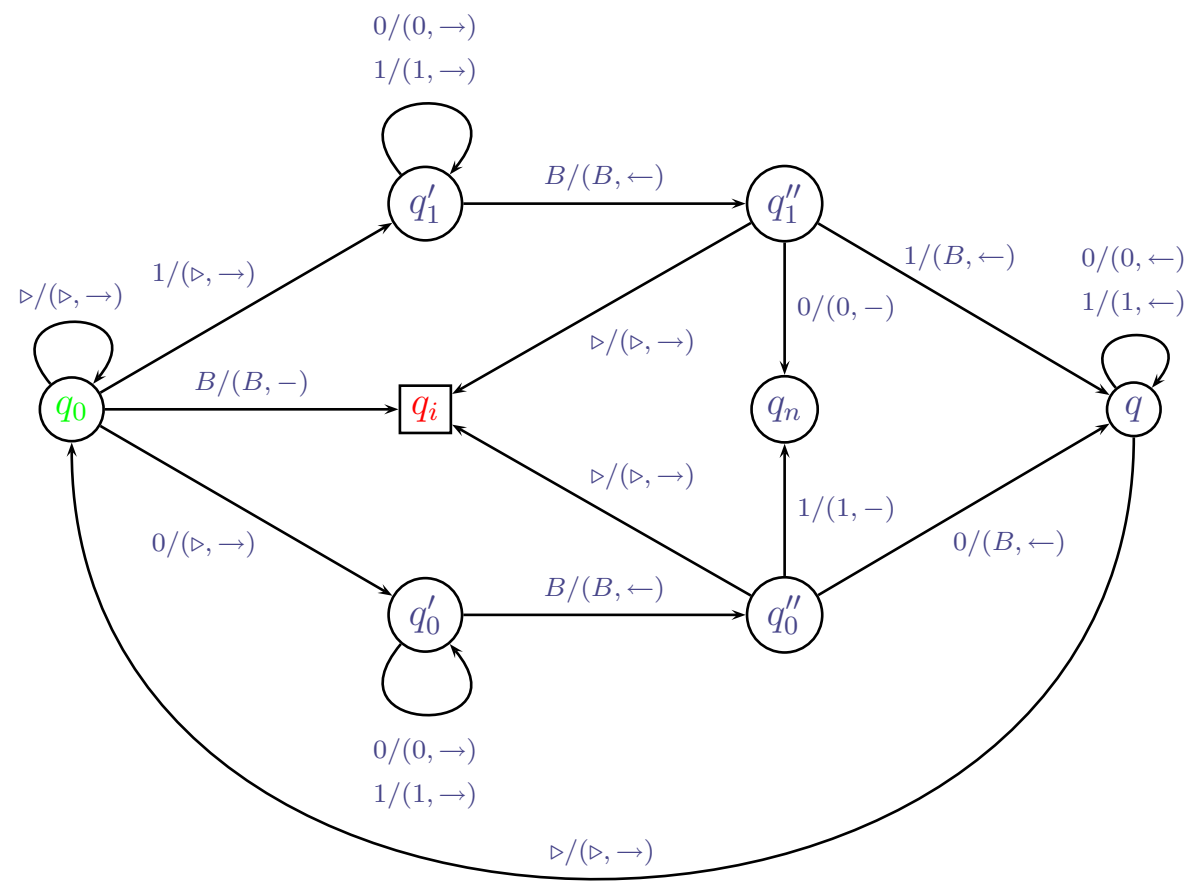
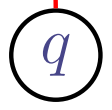

# A palindromákat eldöntő Turing-gép

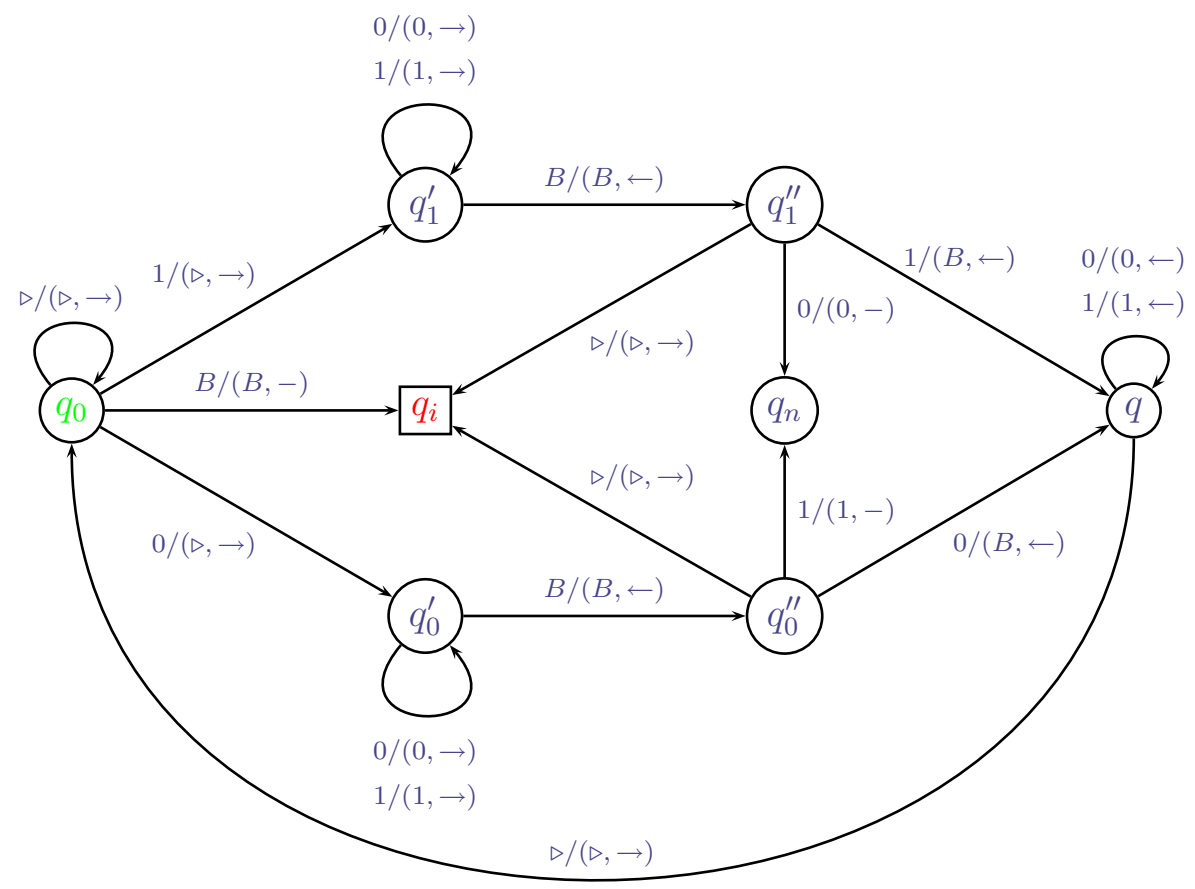
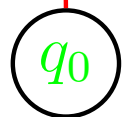

# A palindromákat eldöntő Turing-gép

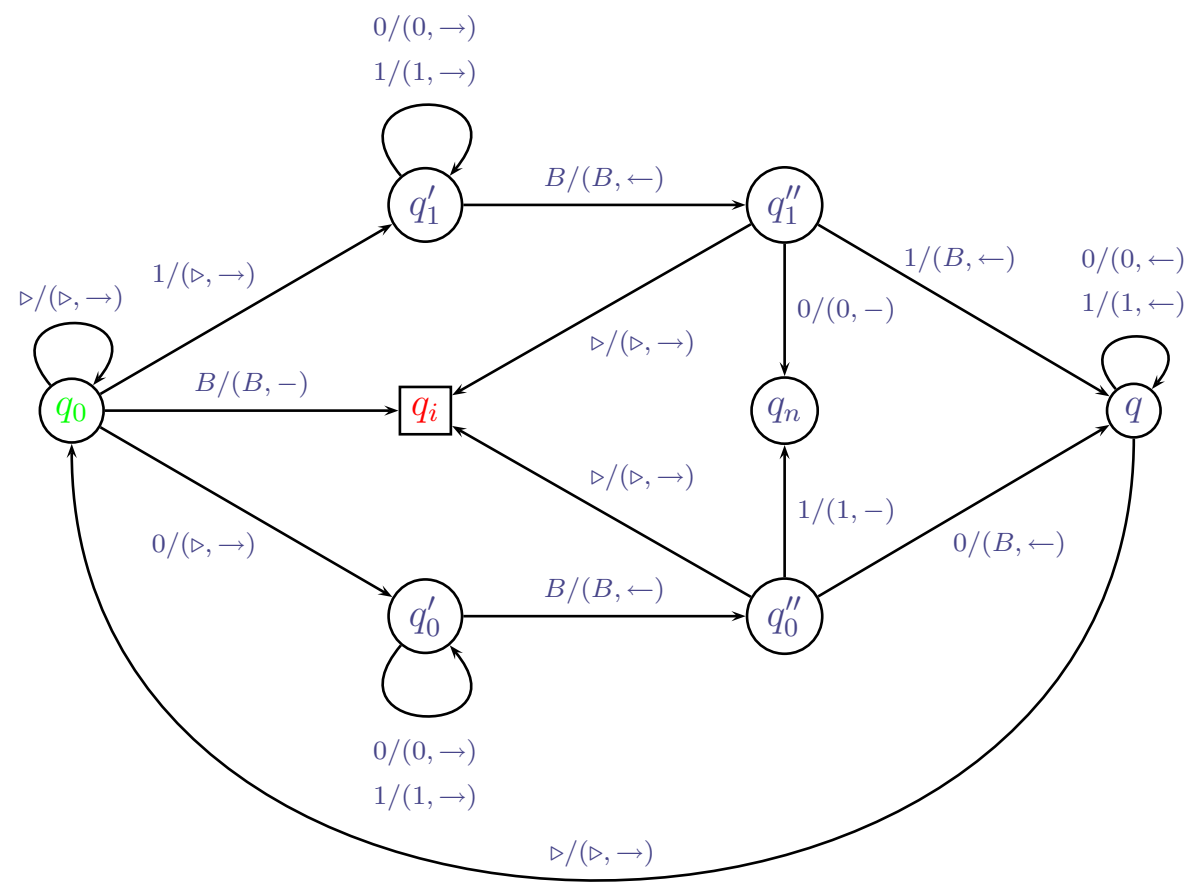
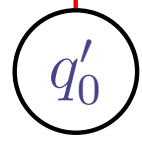

# A palindromákat eldöntő Turing-gép

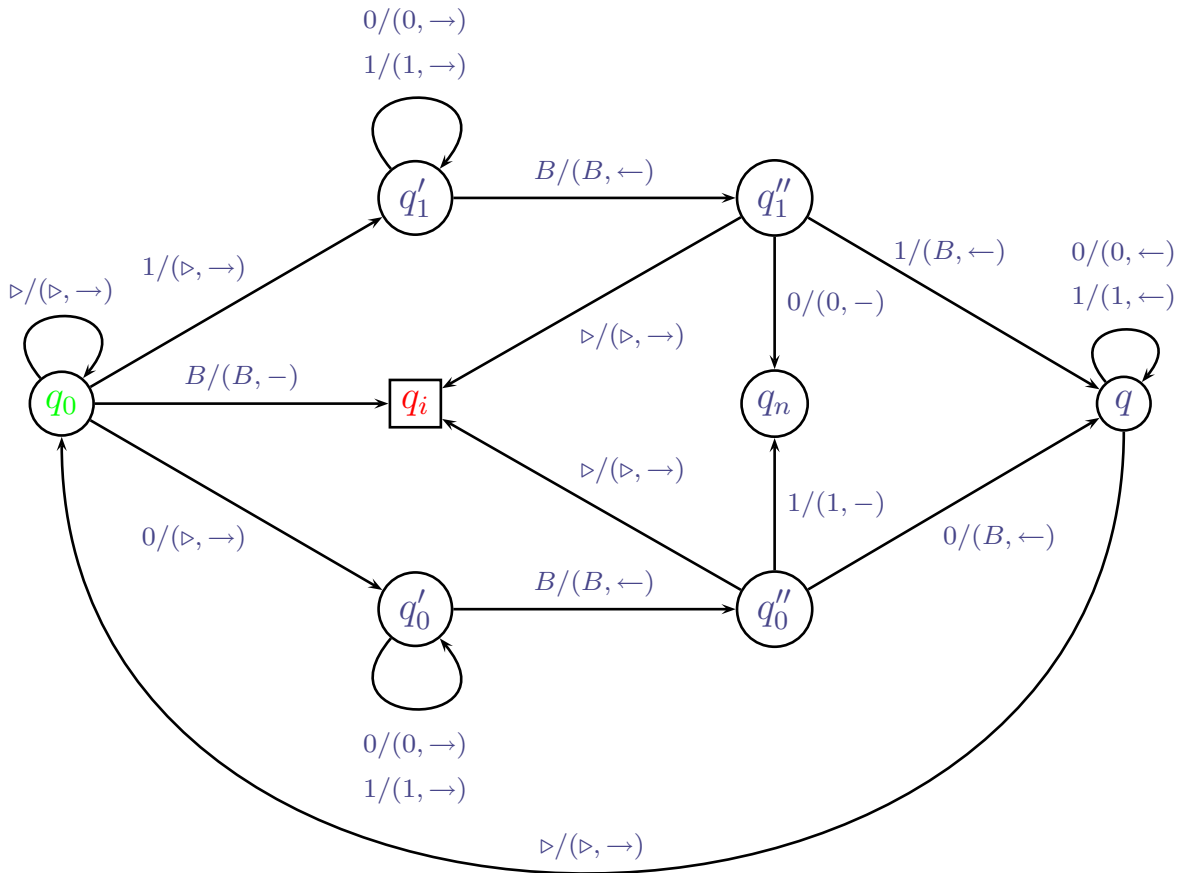
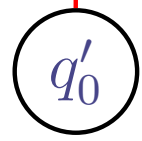
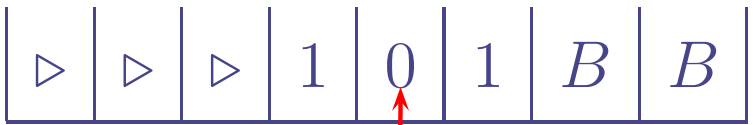

# A palindromákat eldöntő Turing-gép

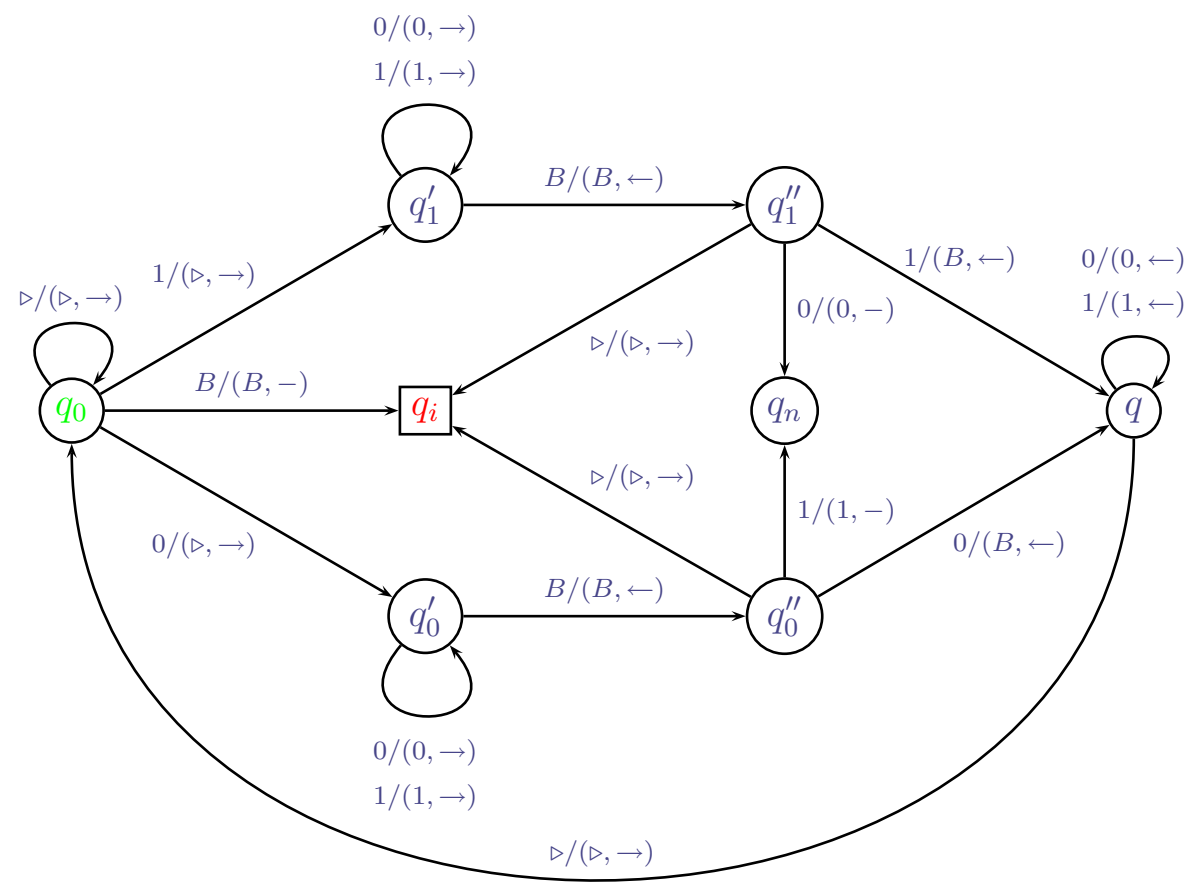
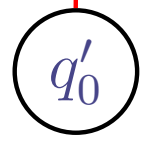

# A palindromákat eldöntő Turing-gép

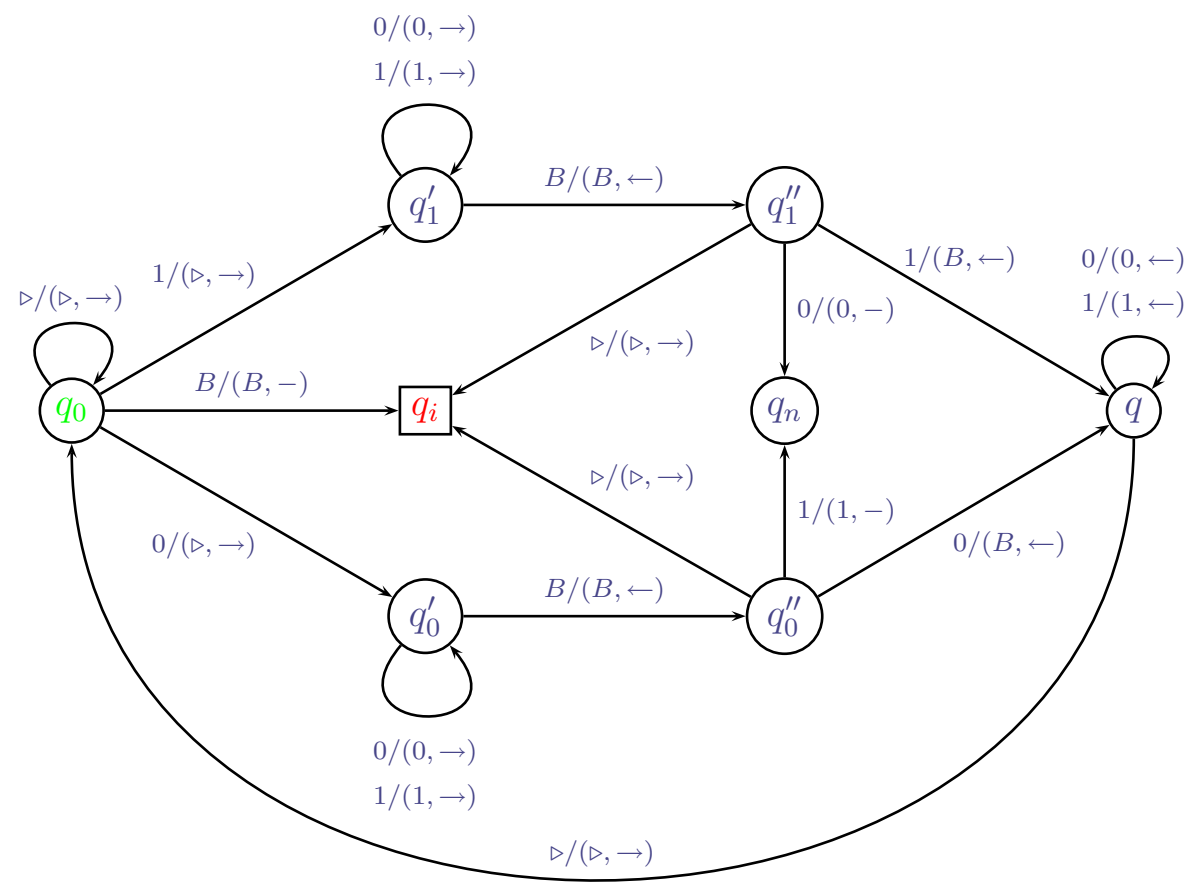
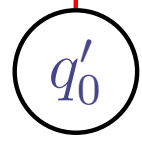

# A palindromákat eldöntő Turing-gép

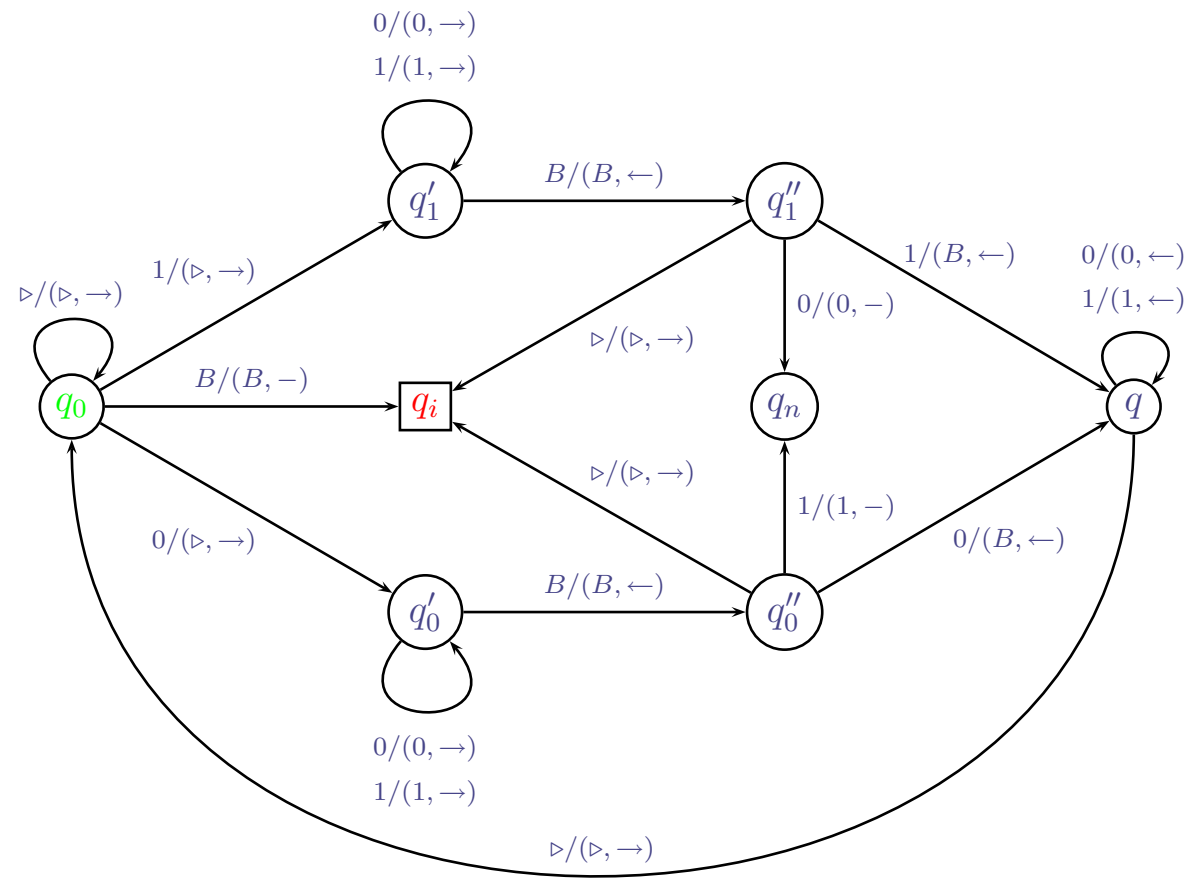
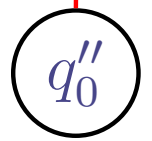

# A palindromákat eldöntő Turing-gép

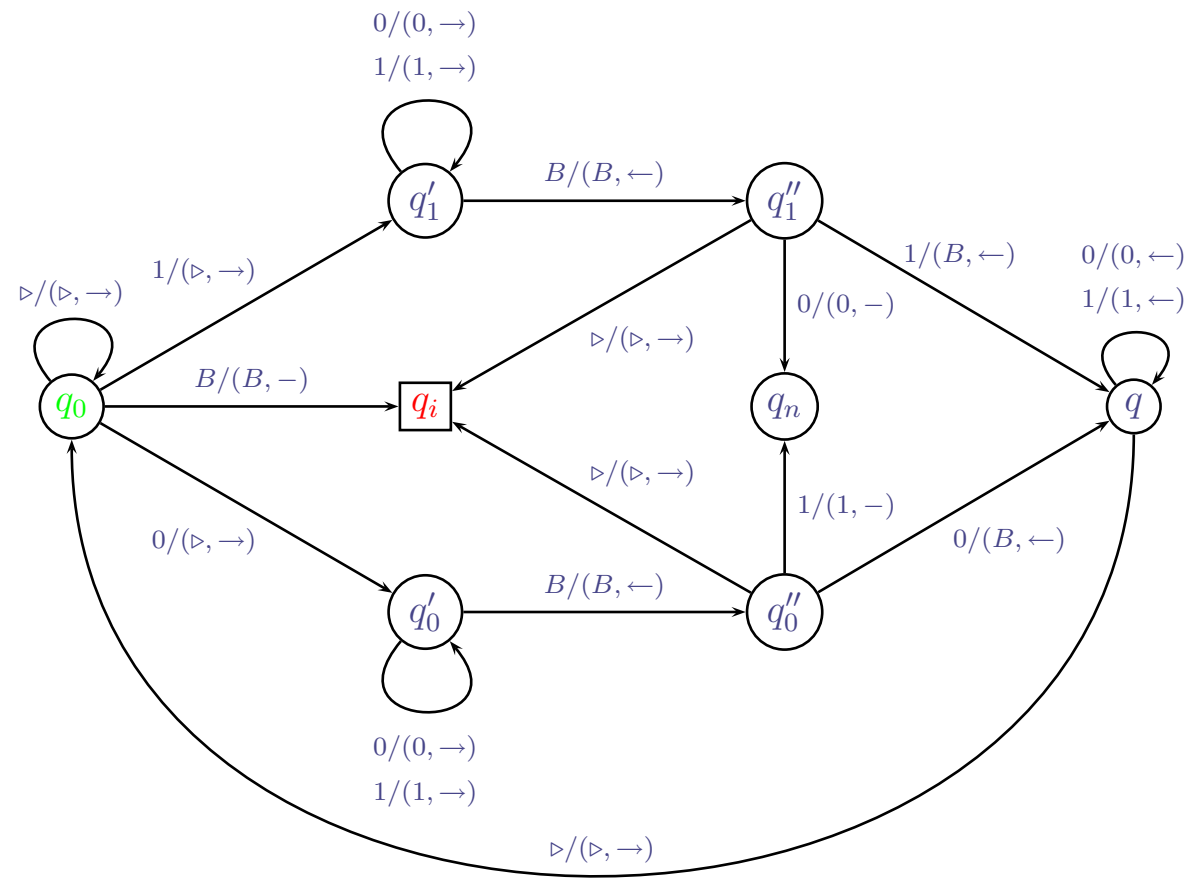
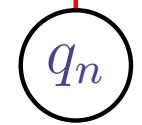



# A páros hosszúságú palindromákat eldöntő Turing-gép

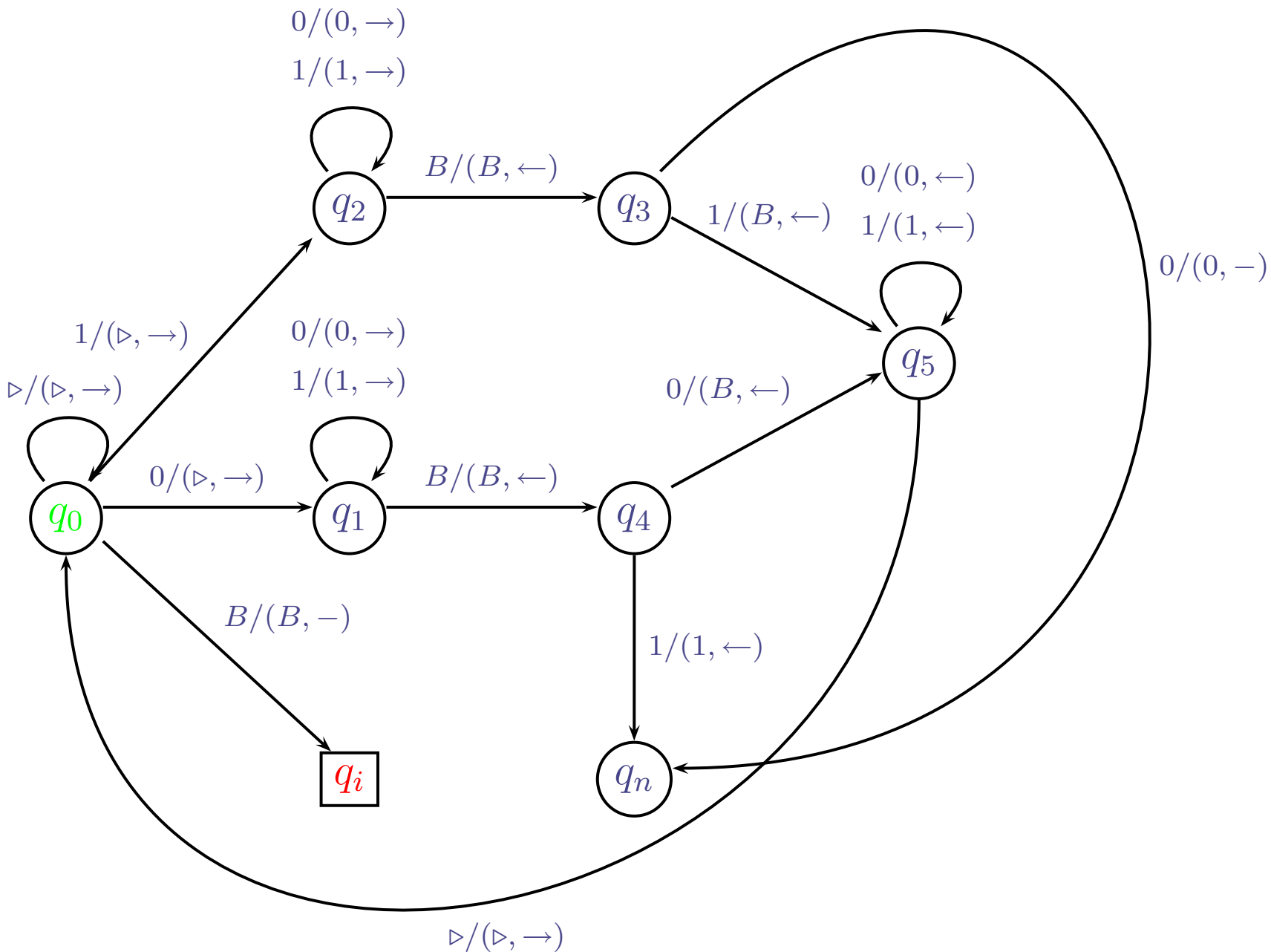

# A páros hosszúságú palindromákat eldöntő Turing-gép

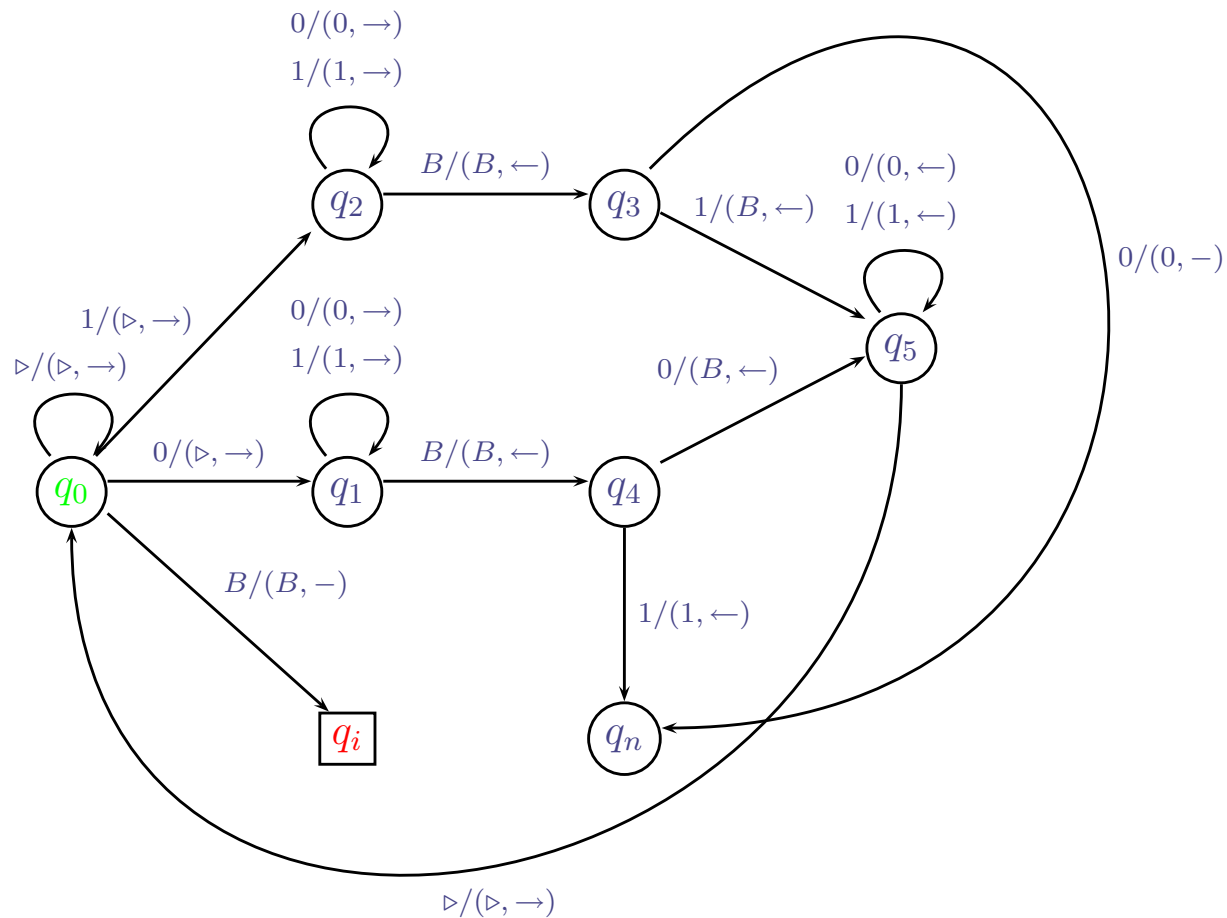
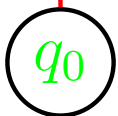

# A páros hosszúságú palindromákat eldöntő Turing-gép

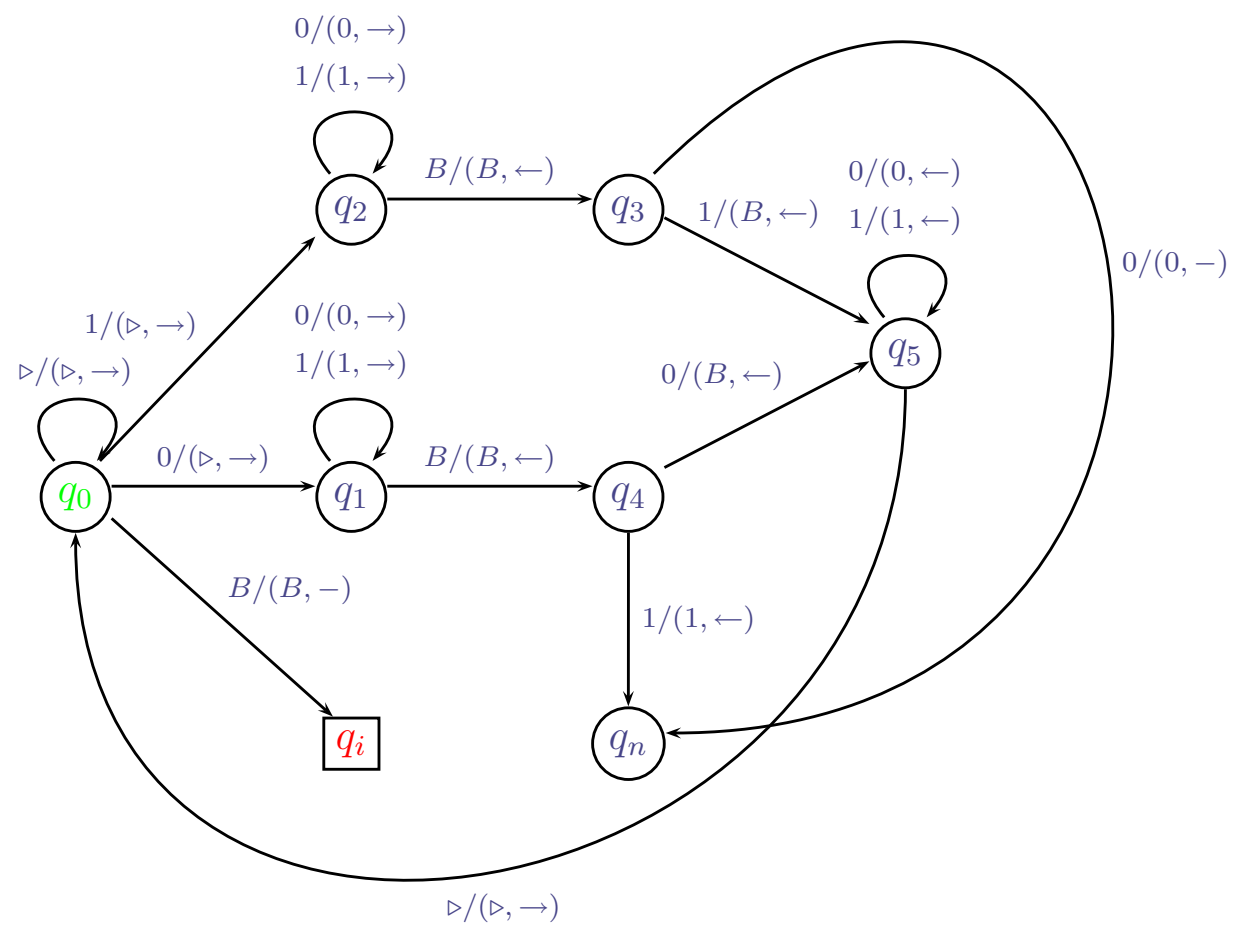
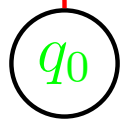

# A páros hosszúságú palindromákat eldöntő Turing-gép

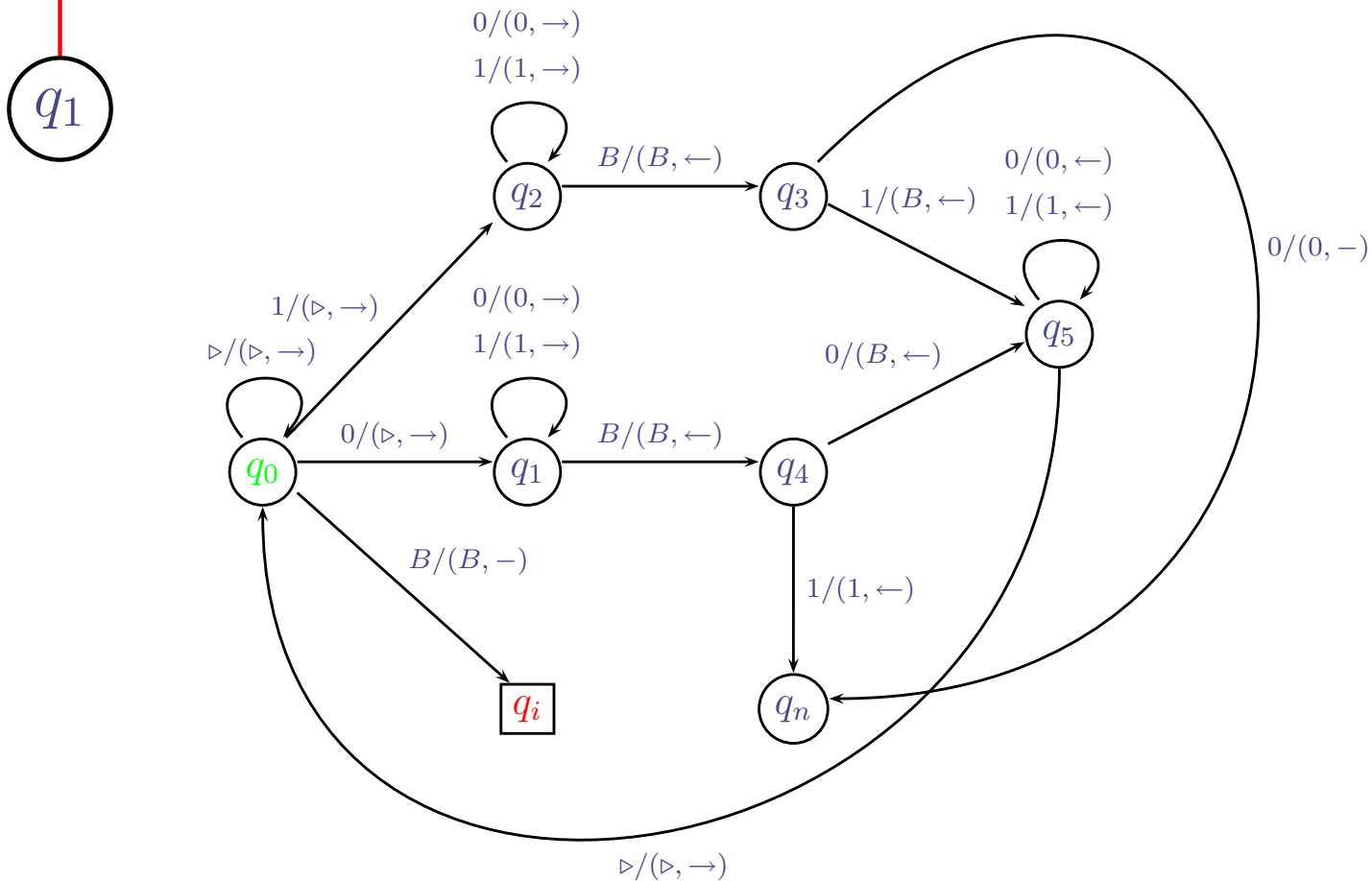
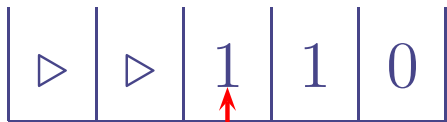

# A páros hosszúságú palindromákat eldöntő Turing-gép

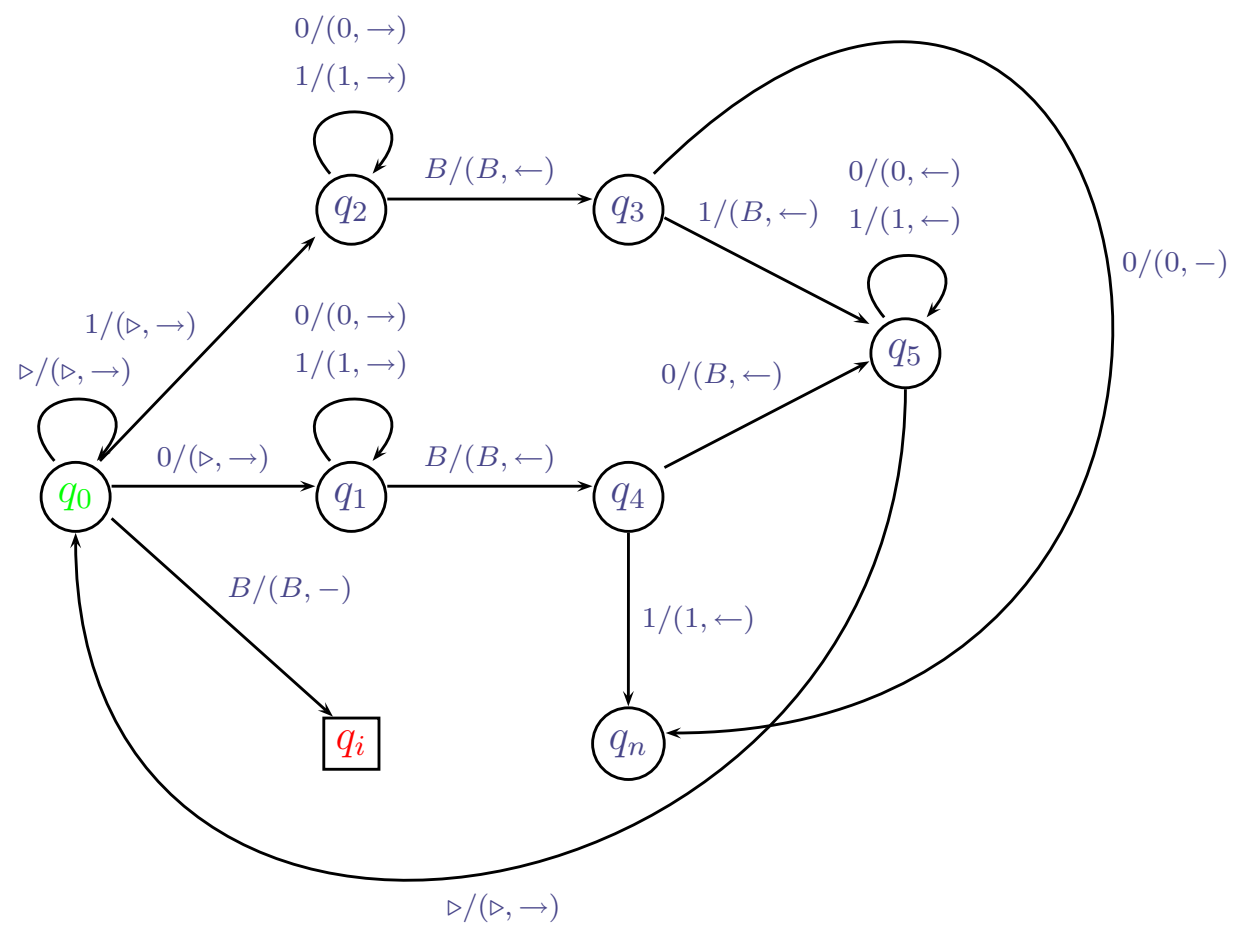
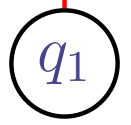

# A páros hosszúságú palindromákat eldöntő Turing-gép

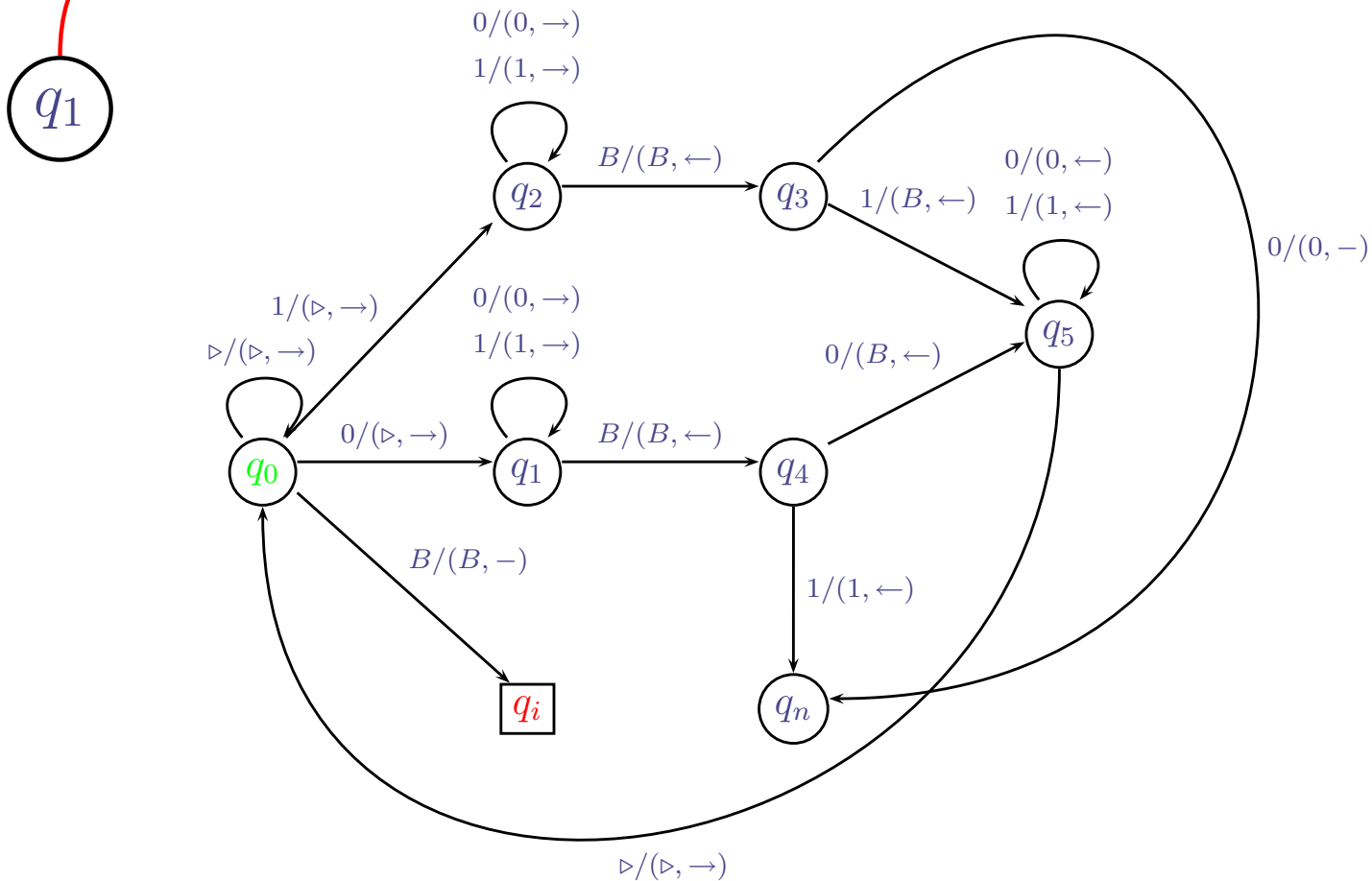

# A páros hosszúságú palindromákat eldöntő Turing-gép

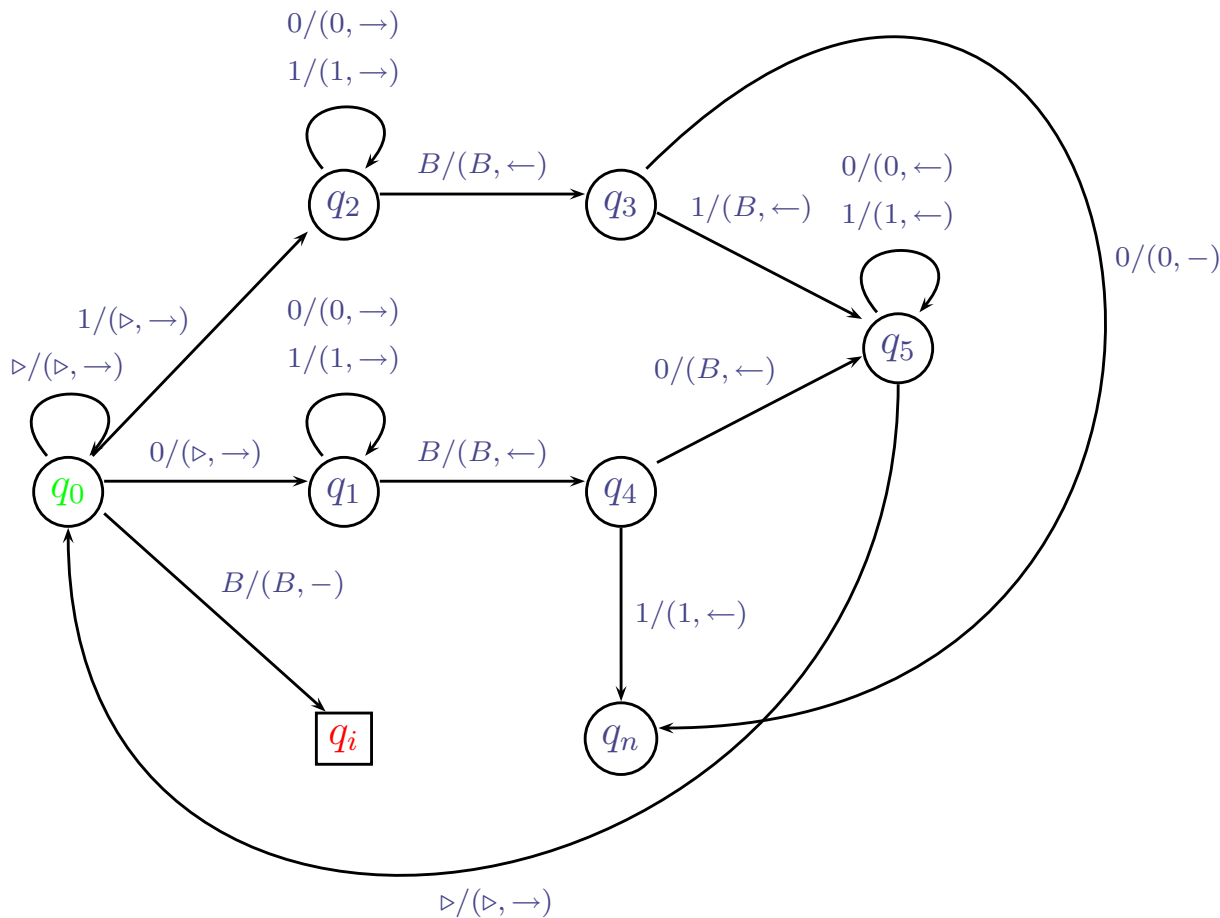
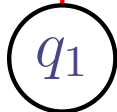

# A páros hosszúságú palindromákat eldöntő Turing-gép

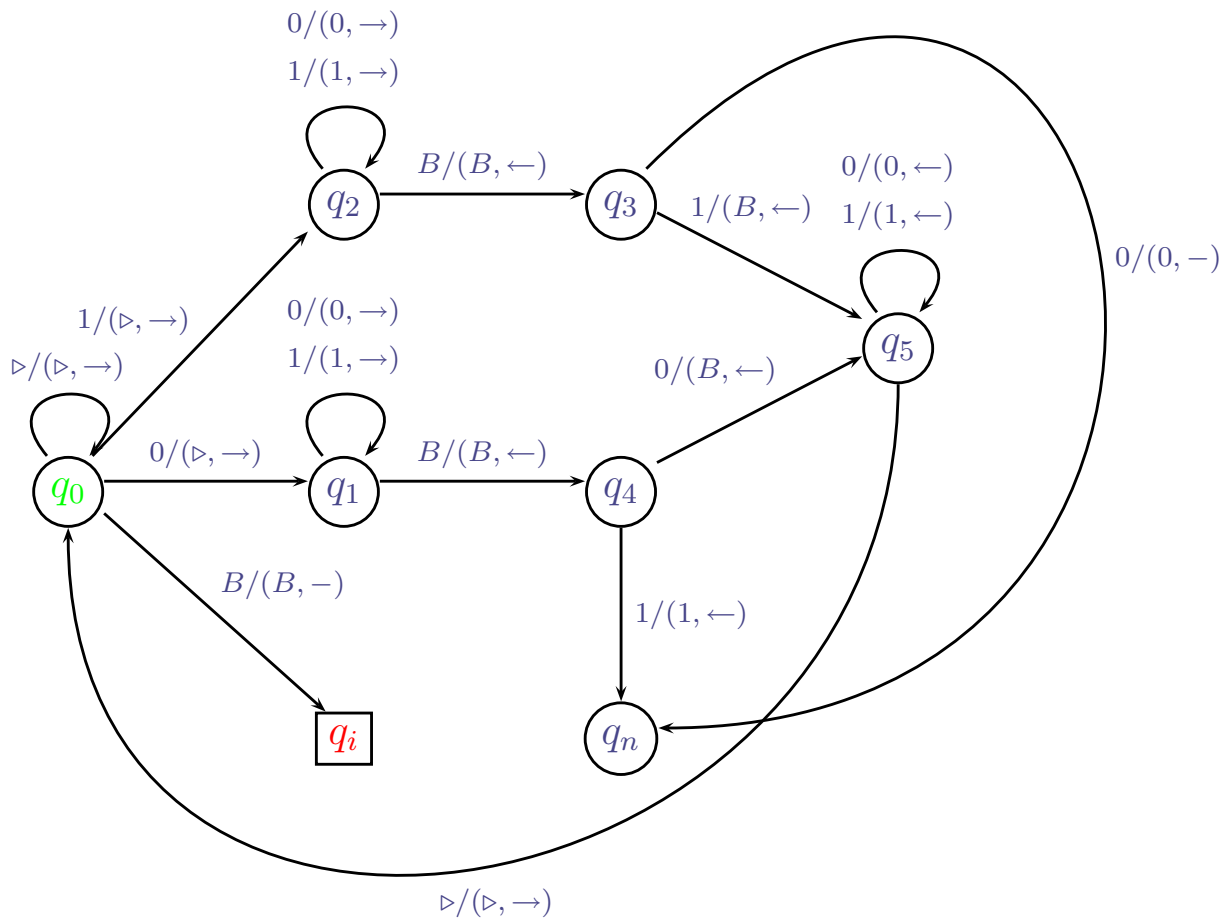



# A páros hosszúságú palindromákat eldöntő Turing-gép

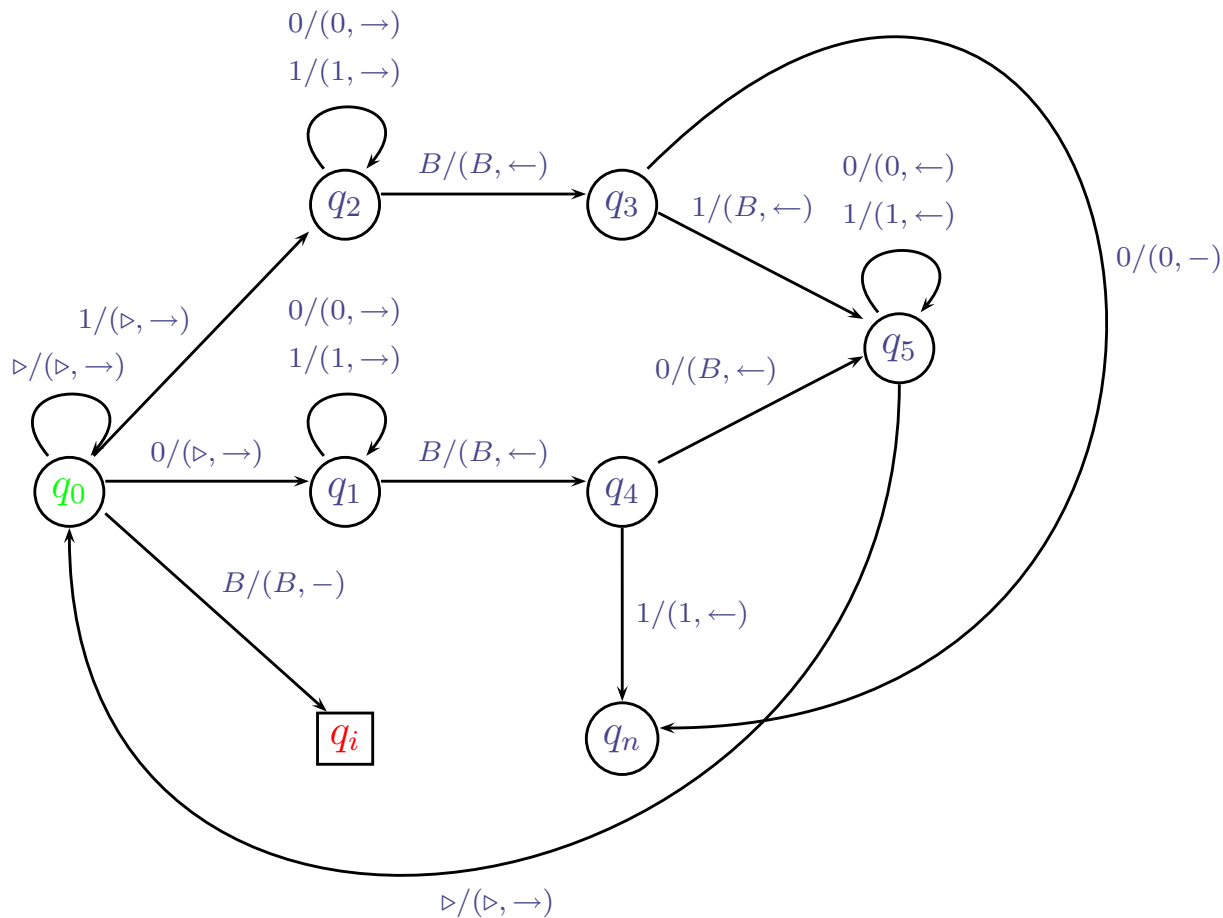
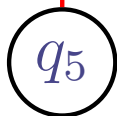
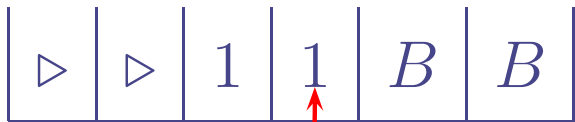

# A páros hosszúságú palindromákat eldöntő Turing-gép

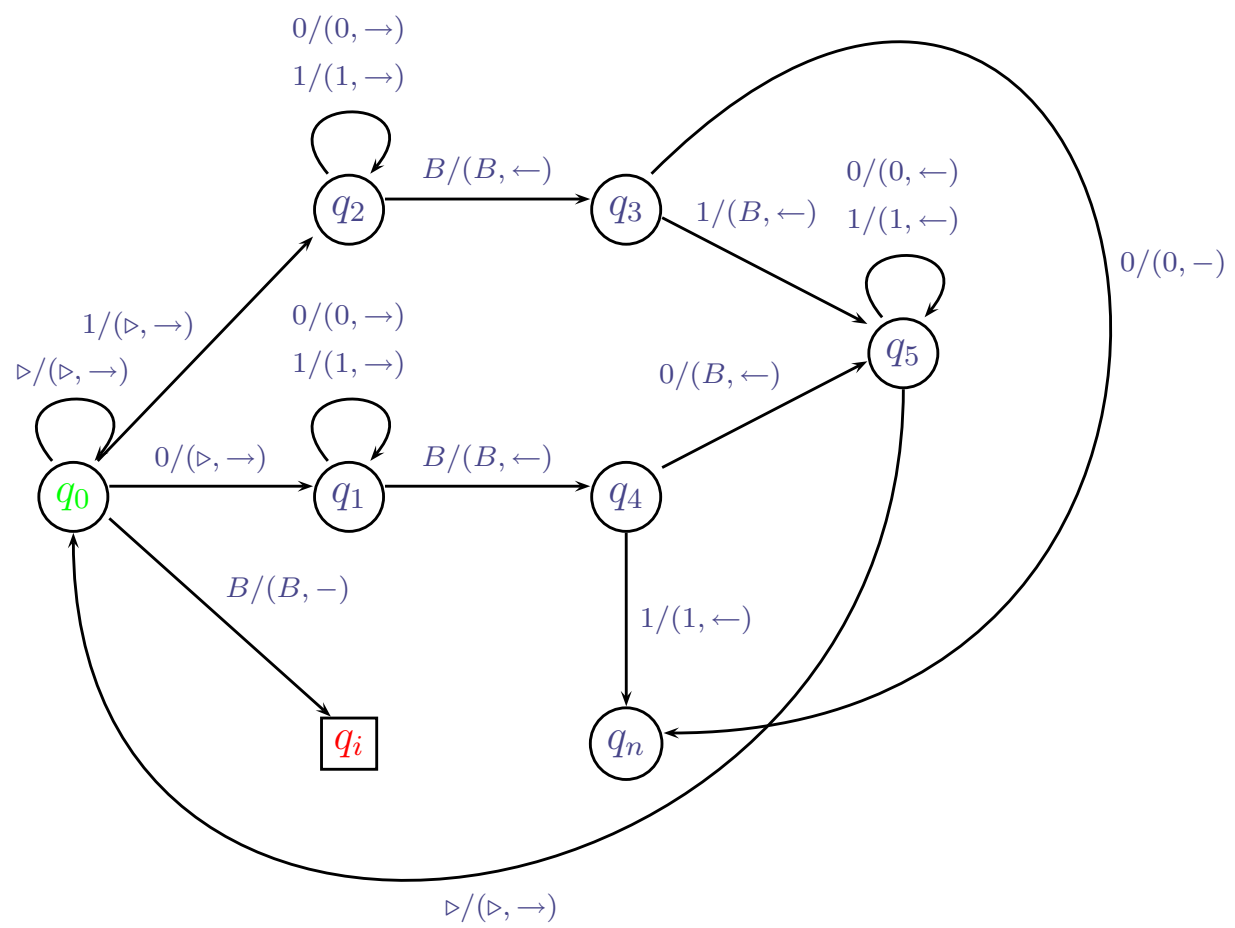
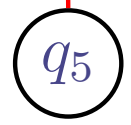
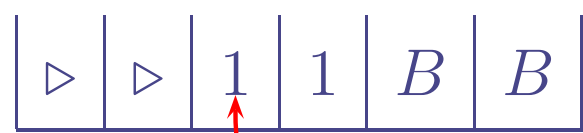

# A páros hosszúságú palindromákat eldöntő Turing-gép

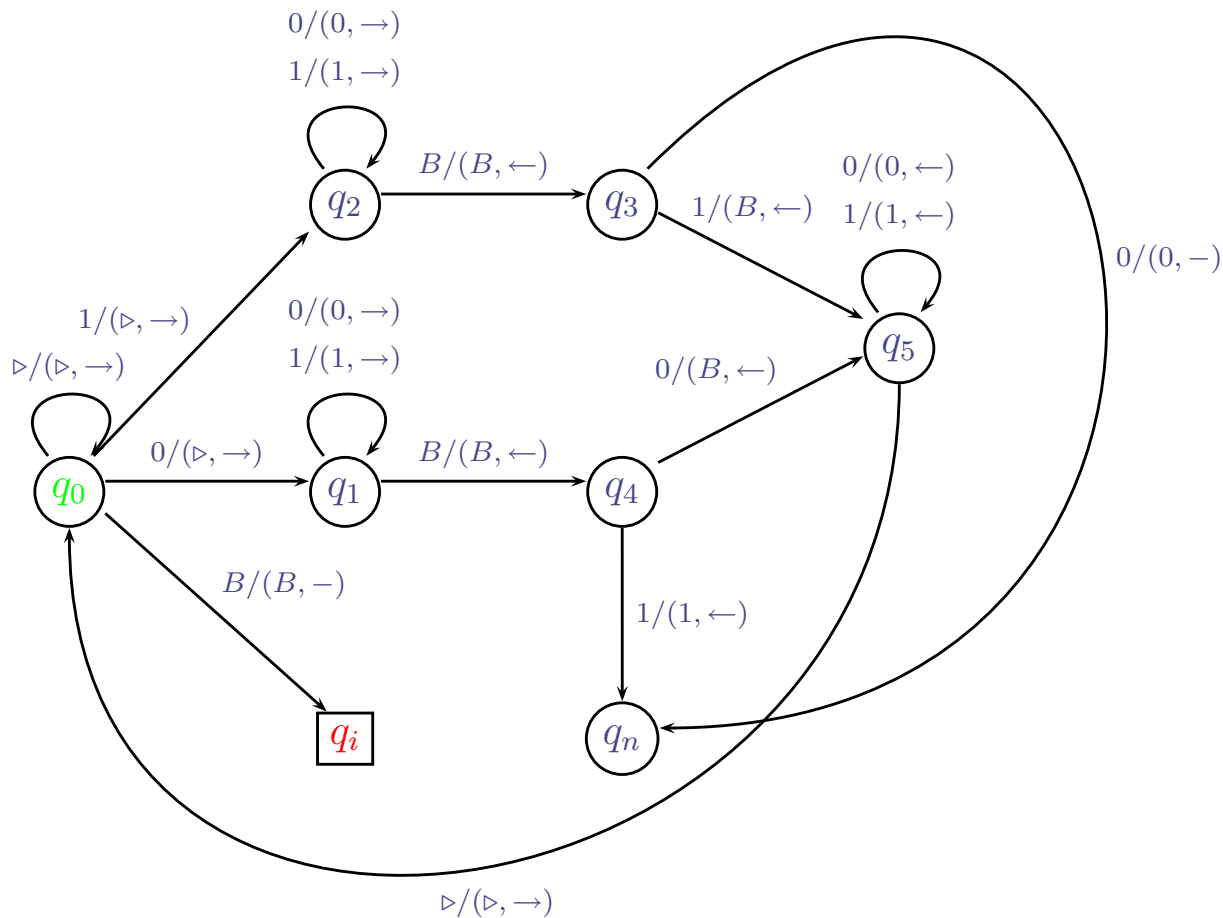
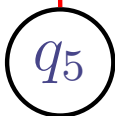

# A páros hosszúságú palindromákat eldöntő Turing-gép

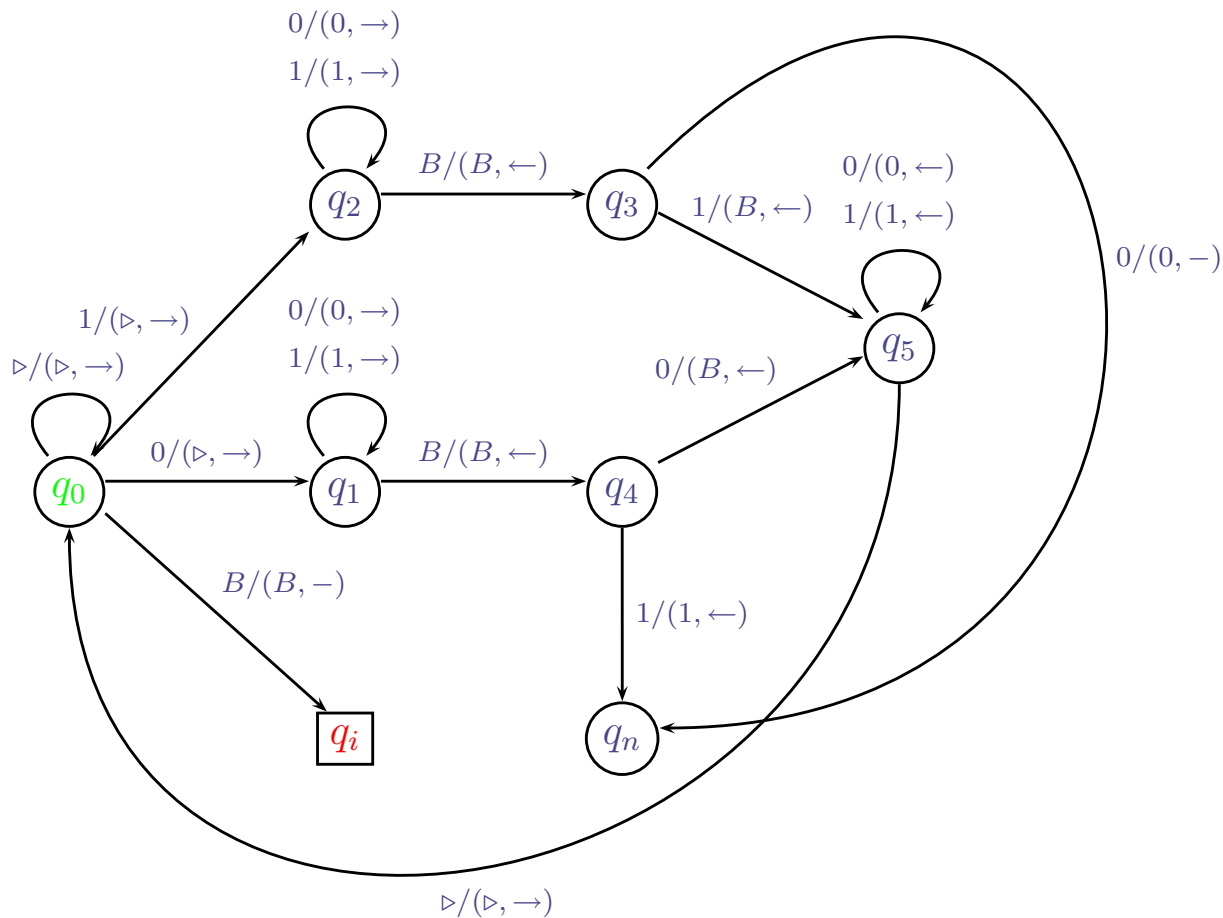
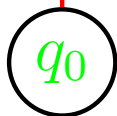
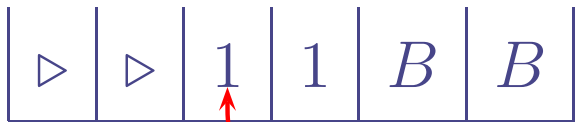

# A páros hosszúságú palindromákat eldöntő Turing-gép

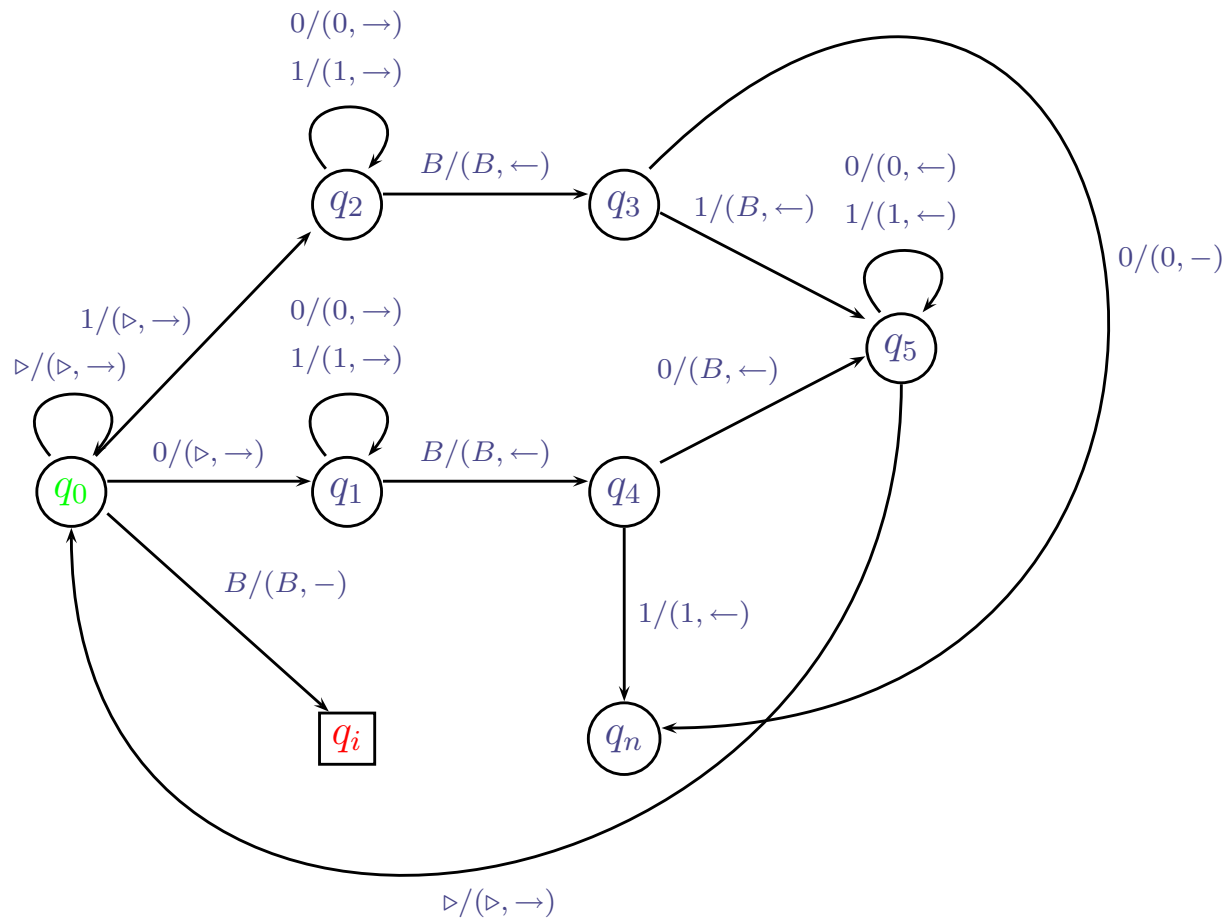
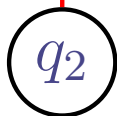
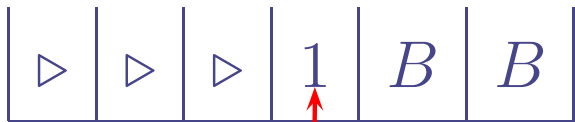

# A páros hosszúságú palindromákat eldöntő Turing-gép

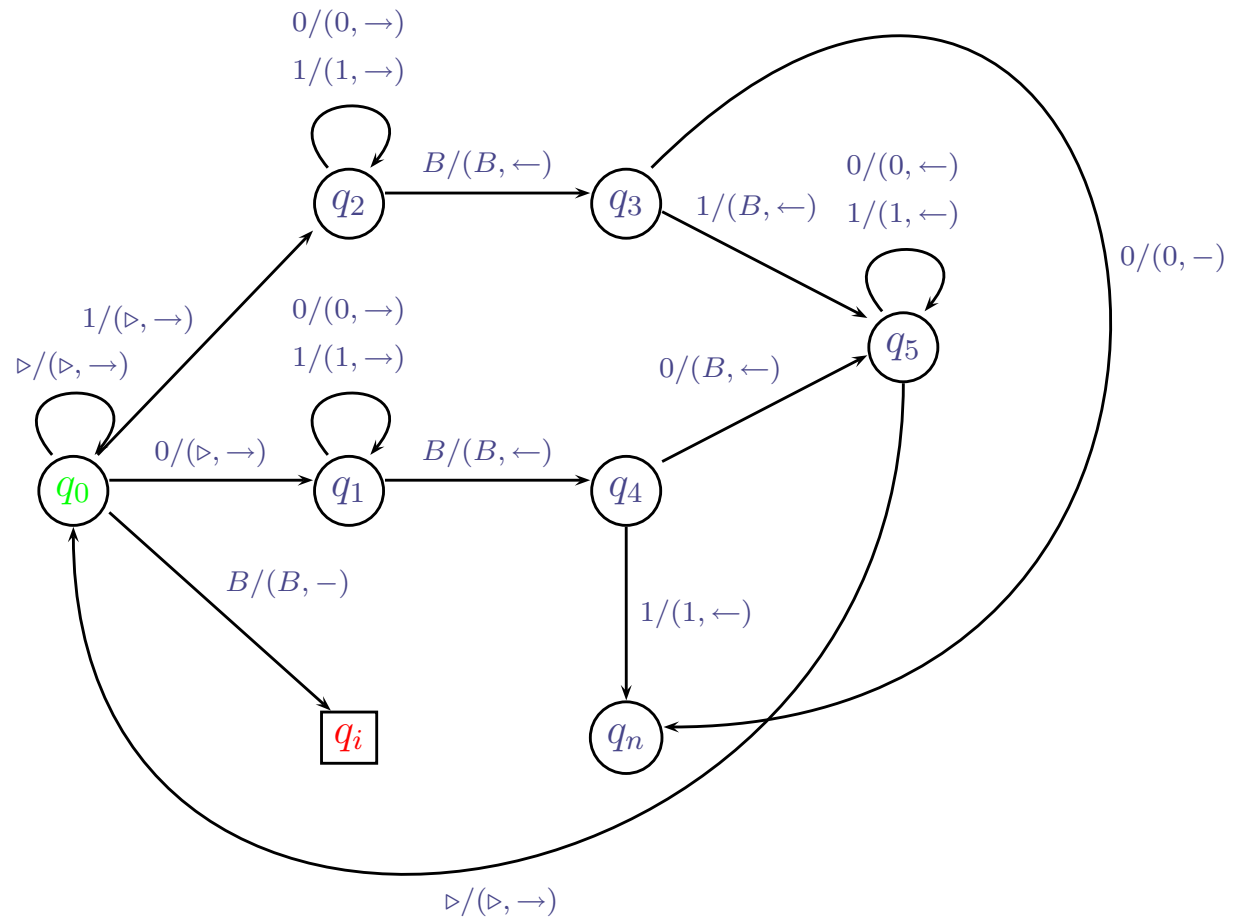

# A páros hosszúságú palindromákat eldöntő Turing-gép

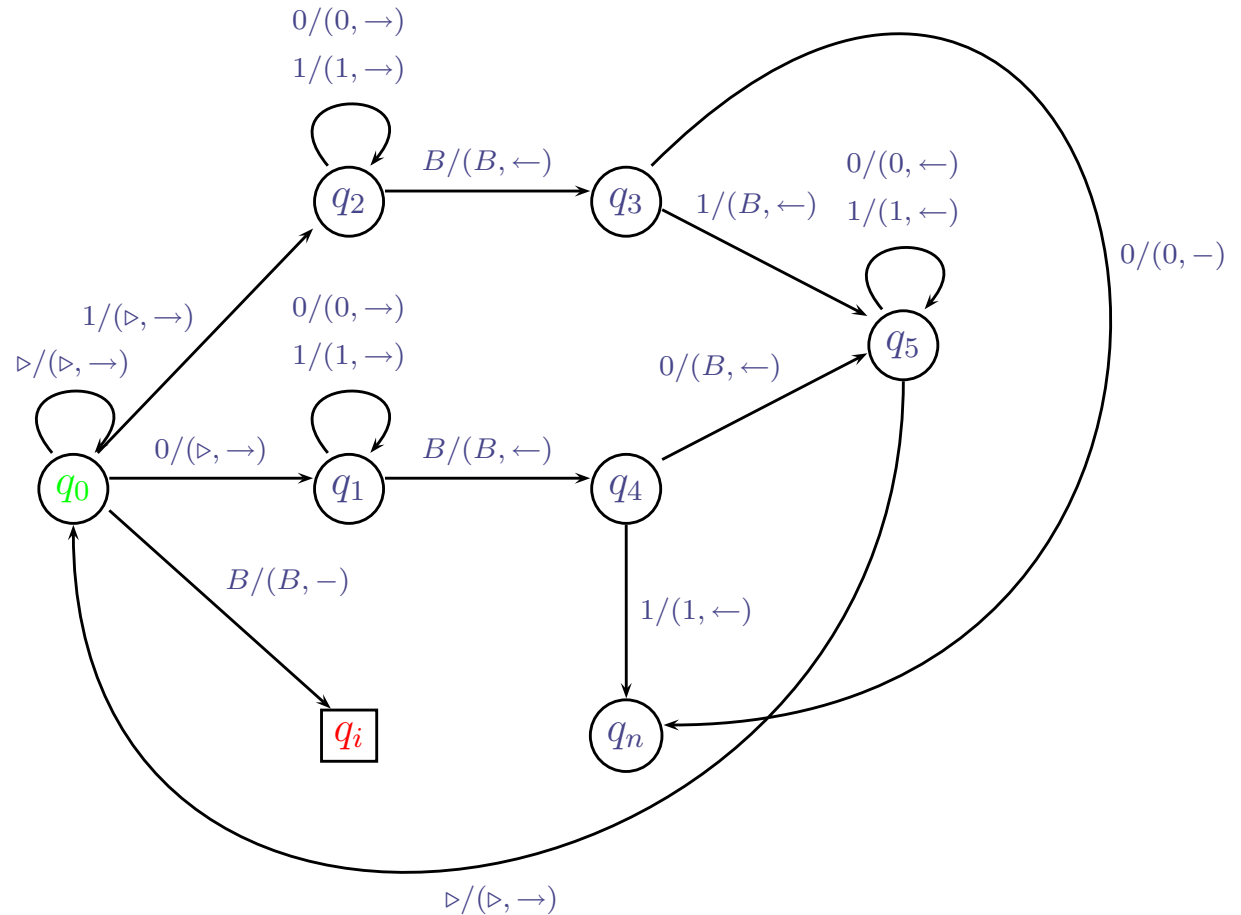
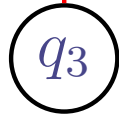
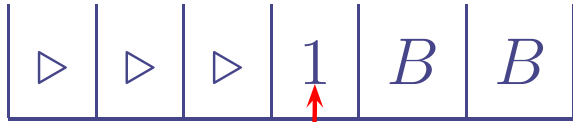

# A páros hosszúságú palindromákat eldöntő Turing-gép

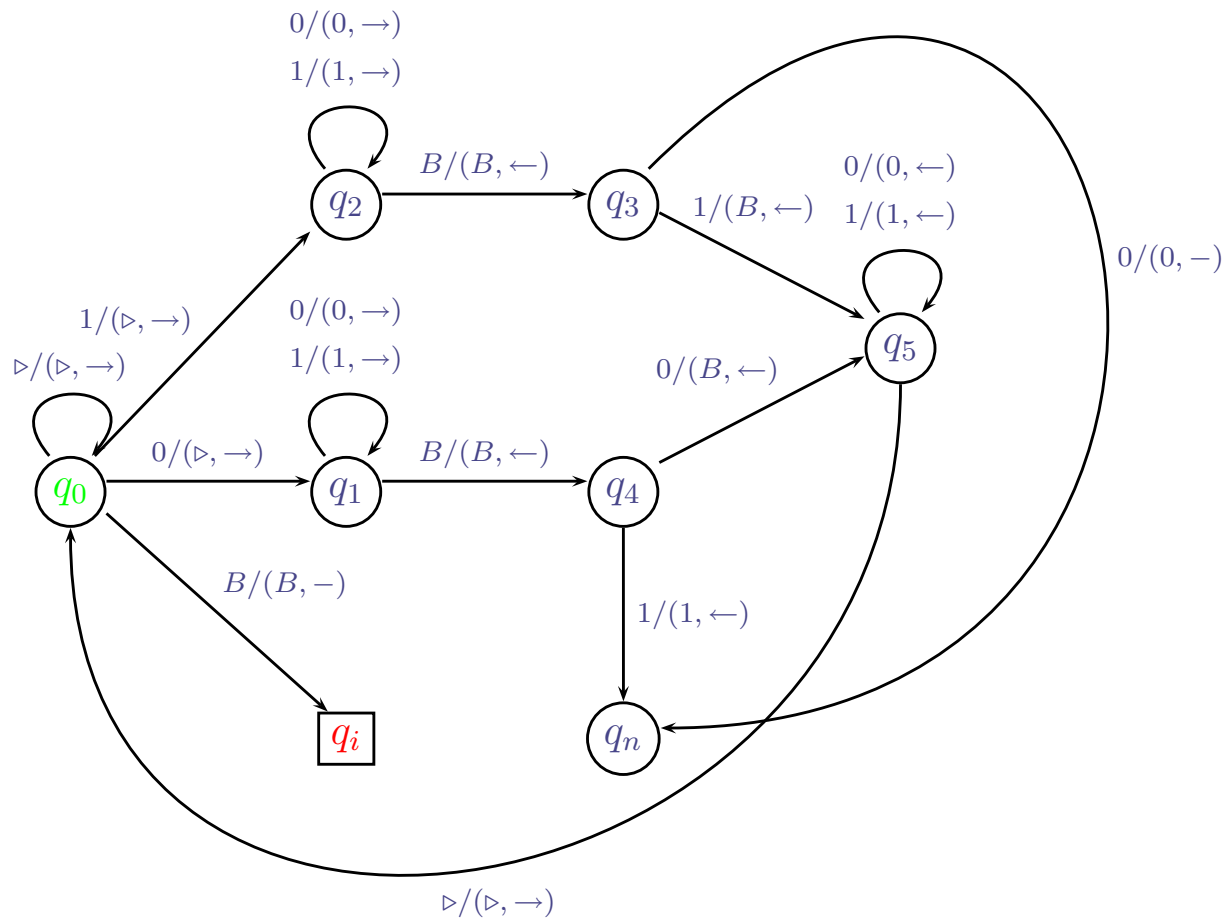
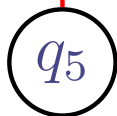



# A páros hosszúságú palindromákat eldöntő Turing-gép

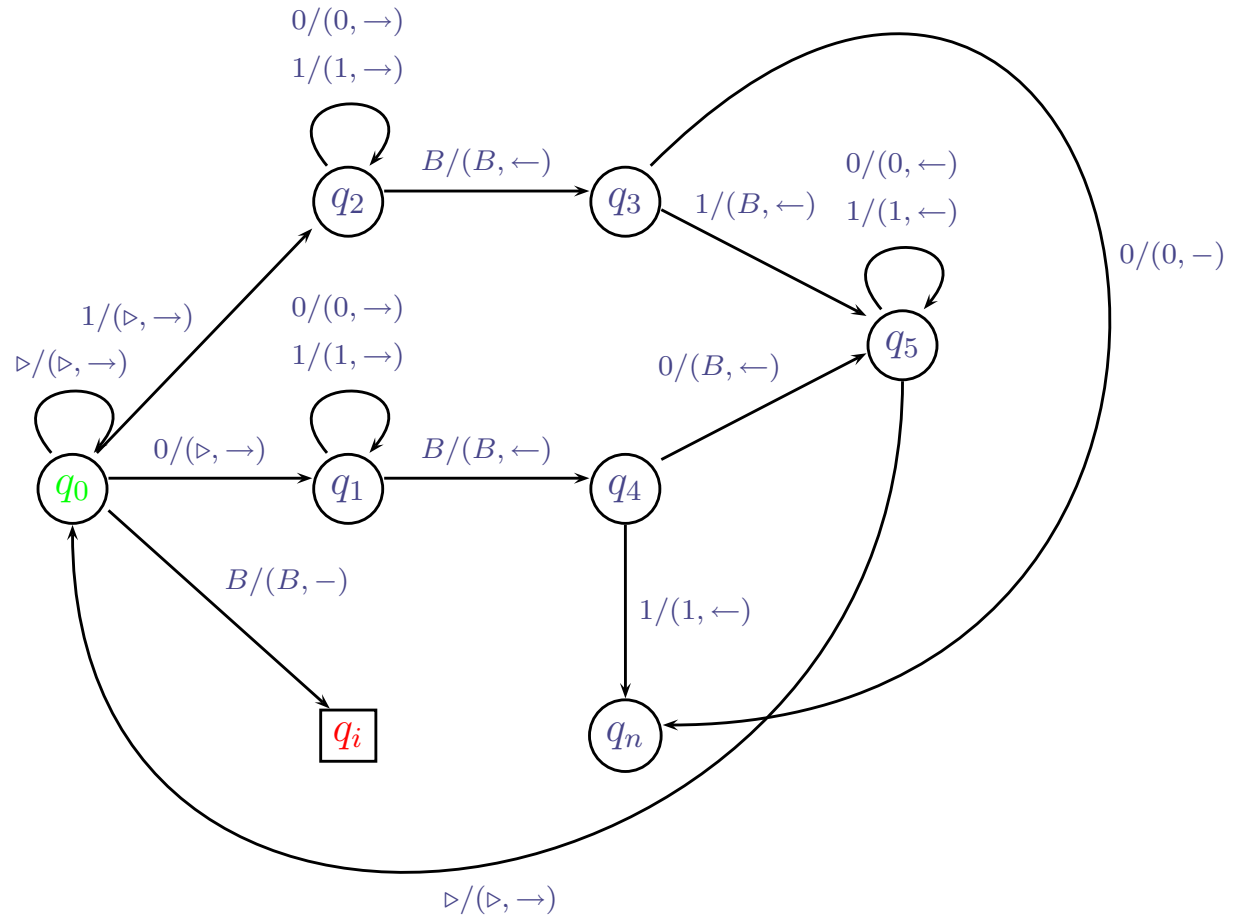
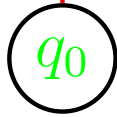
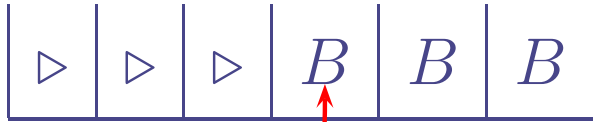

# A páros hosszúságú palindromákat eldöntő Turing-gép

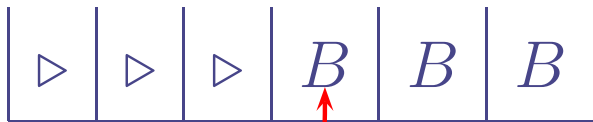

$q_i$

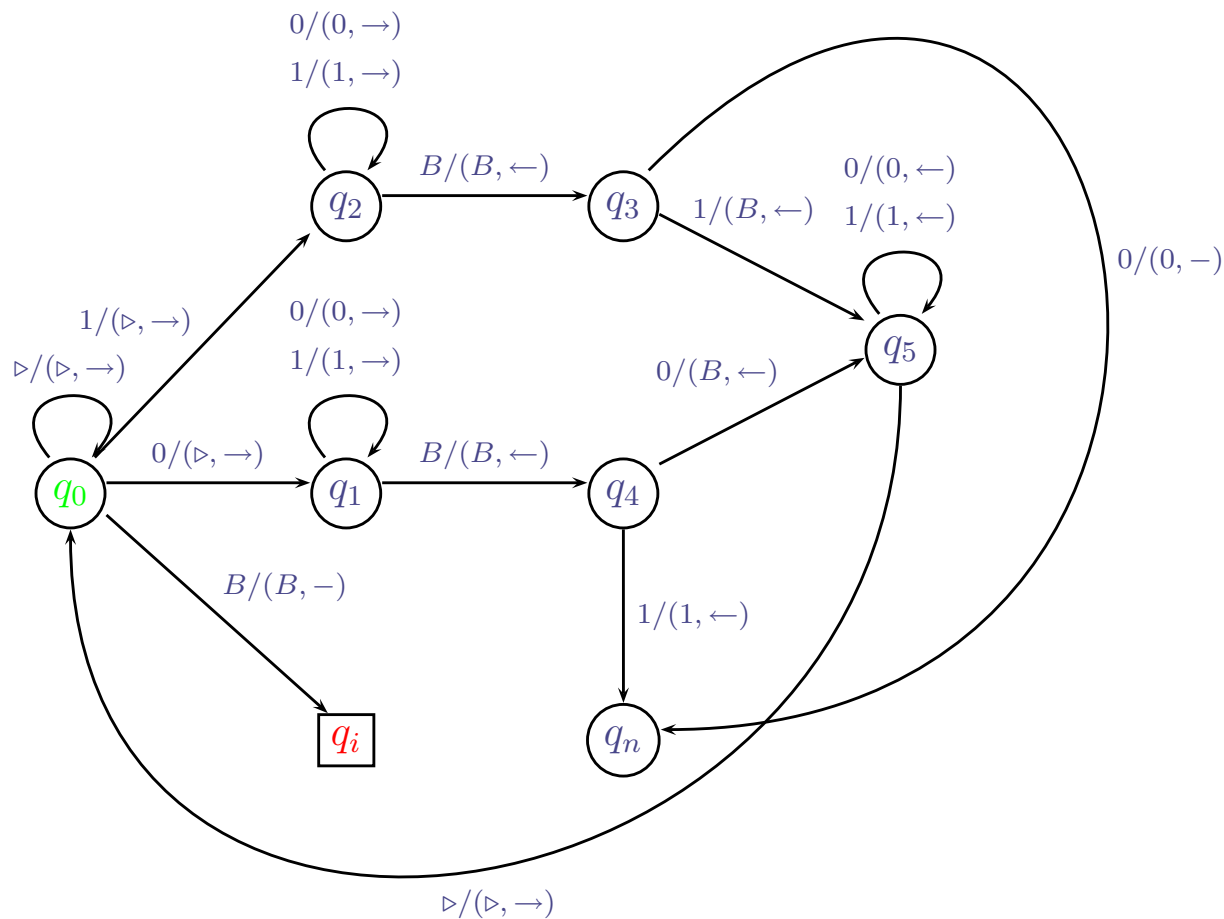

# A páros hosszúságú palindromákat eldöntő Turing-gép

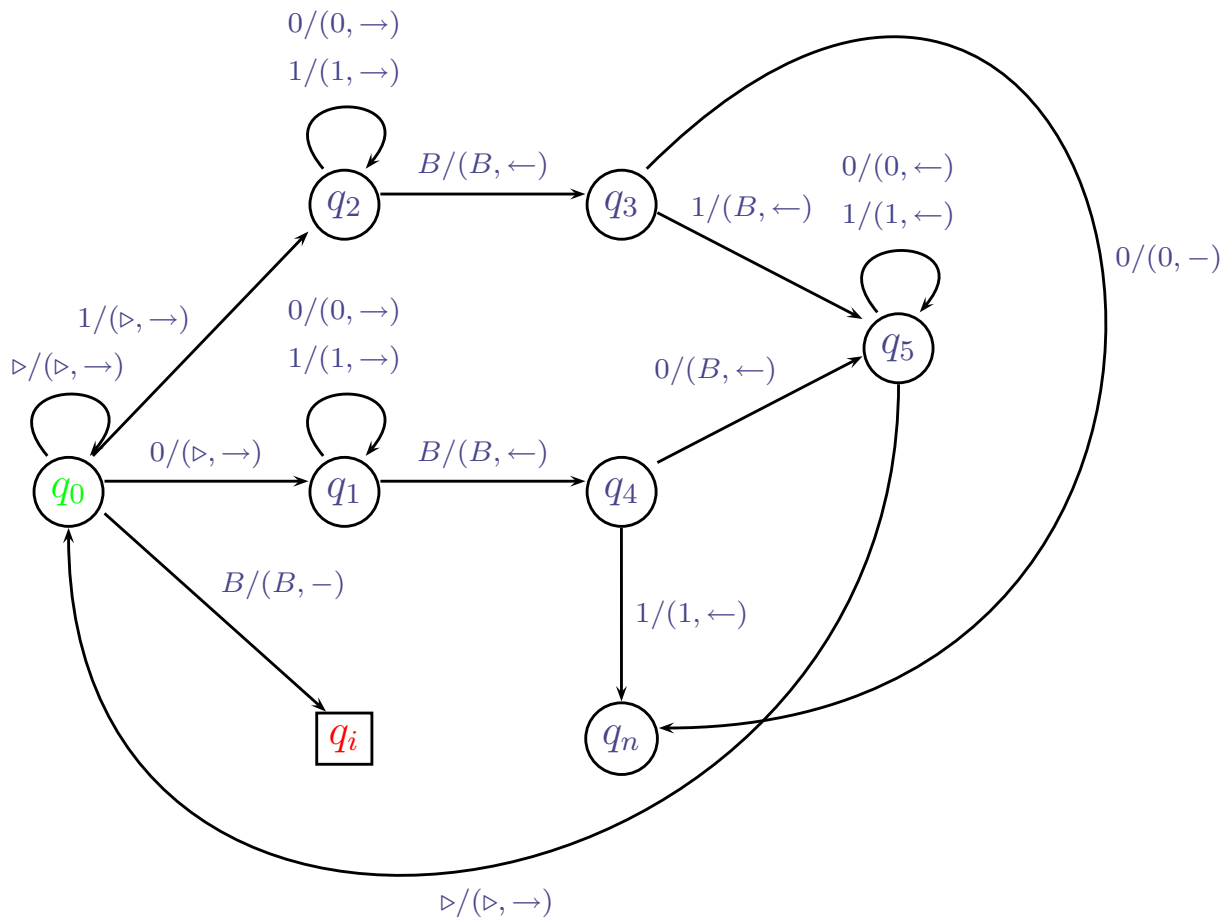
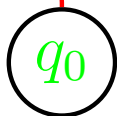

# A páros hosszúságú palindromákat eldöntő Turing-gép

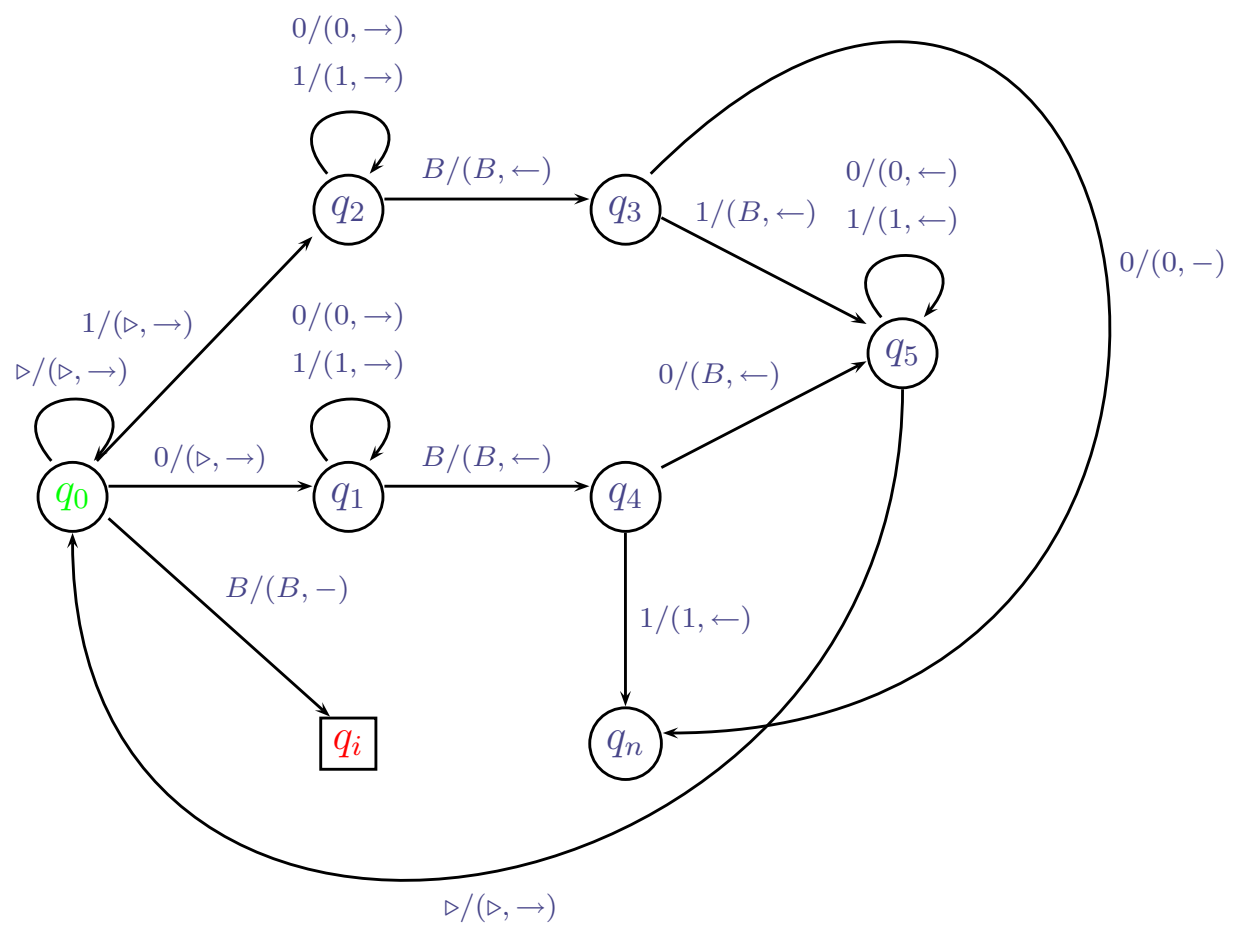
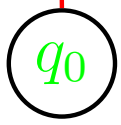

# A páros hosszúságú palindromákat eldöntő Turing-gép

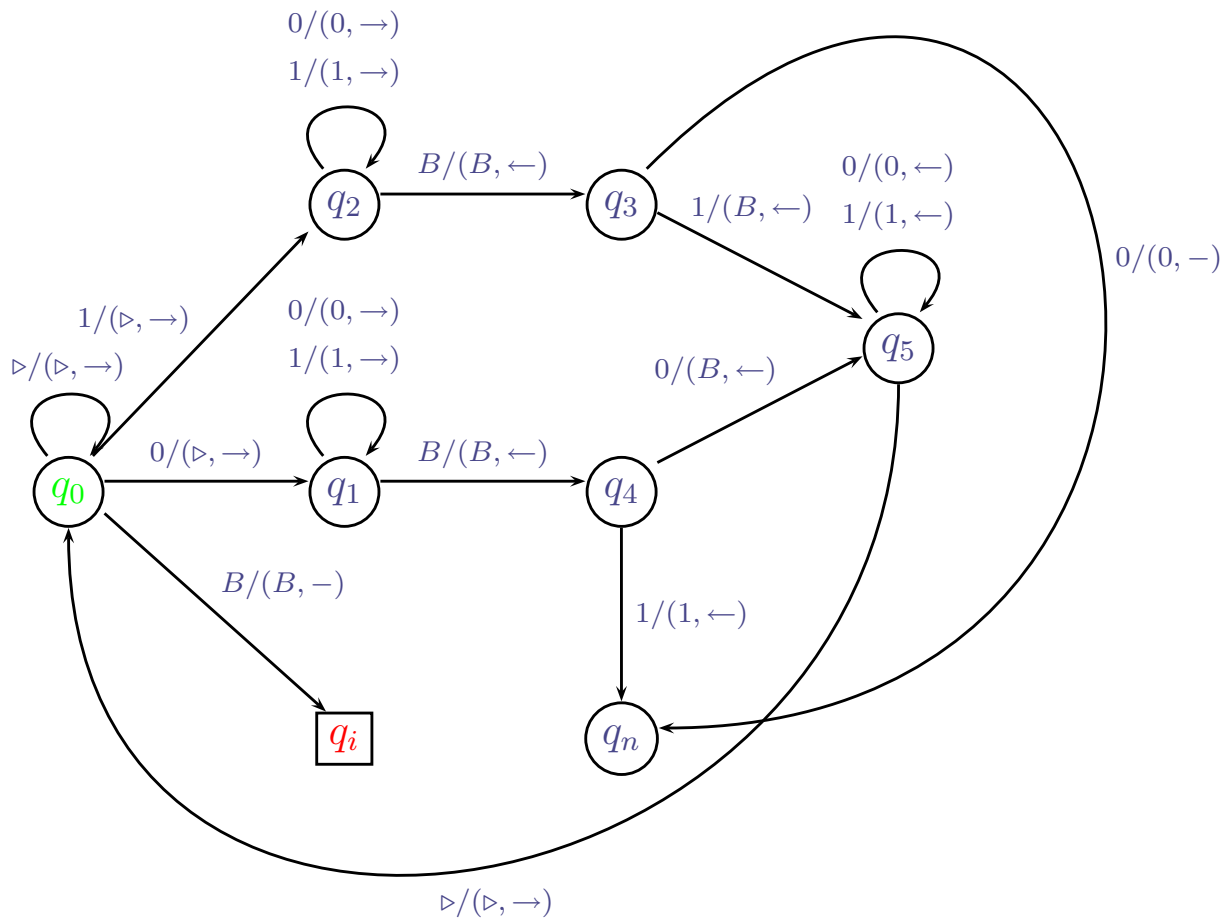

# A páros hosszúságú palindromákat eldöntő Turing-gép

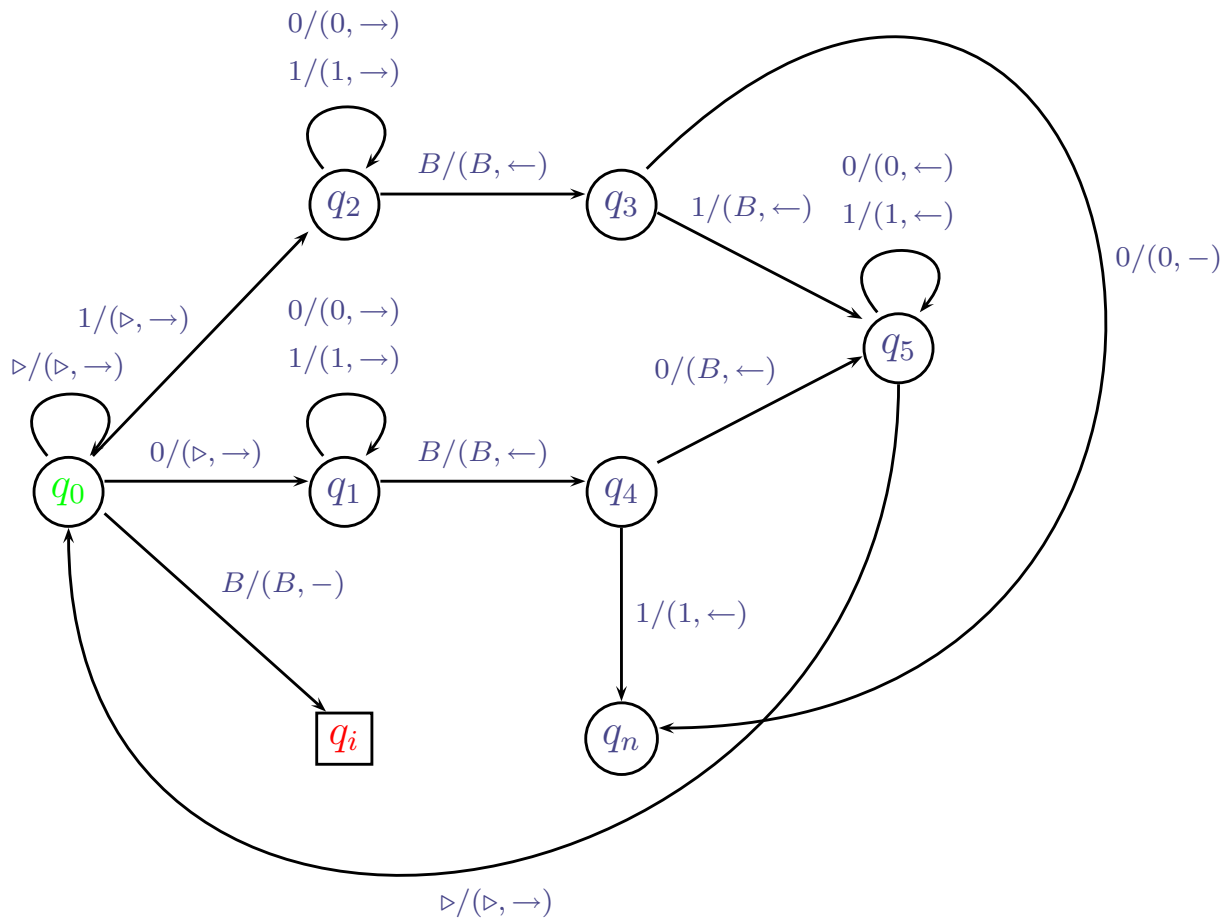
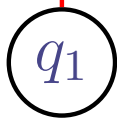
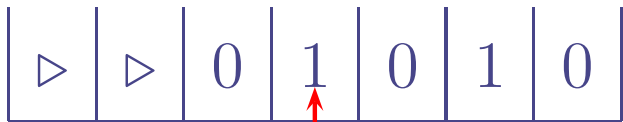

# A páros hosszúságú palindromákat eldöntő Turing-gép

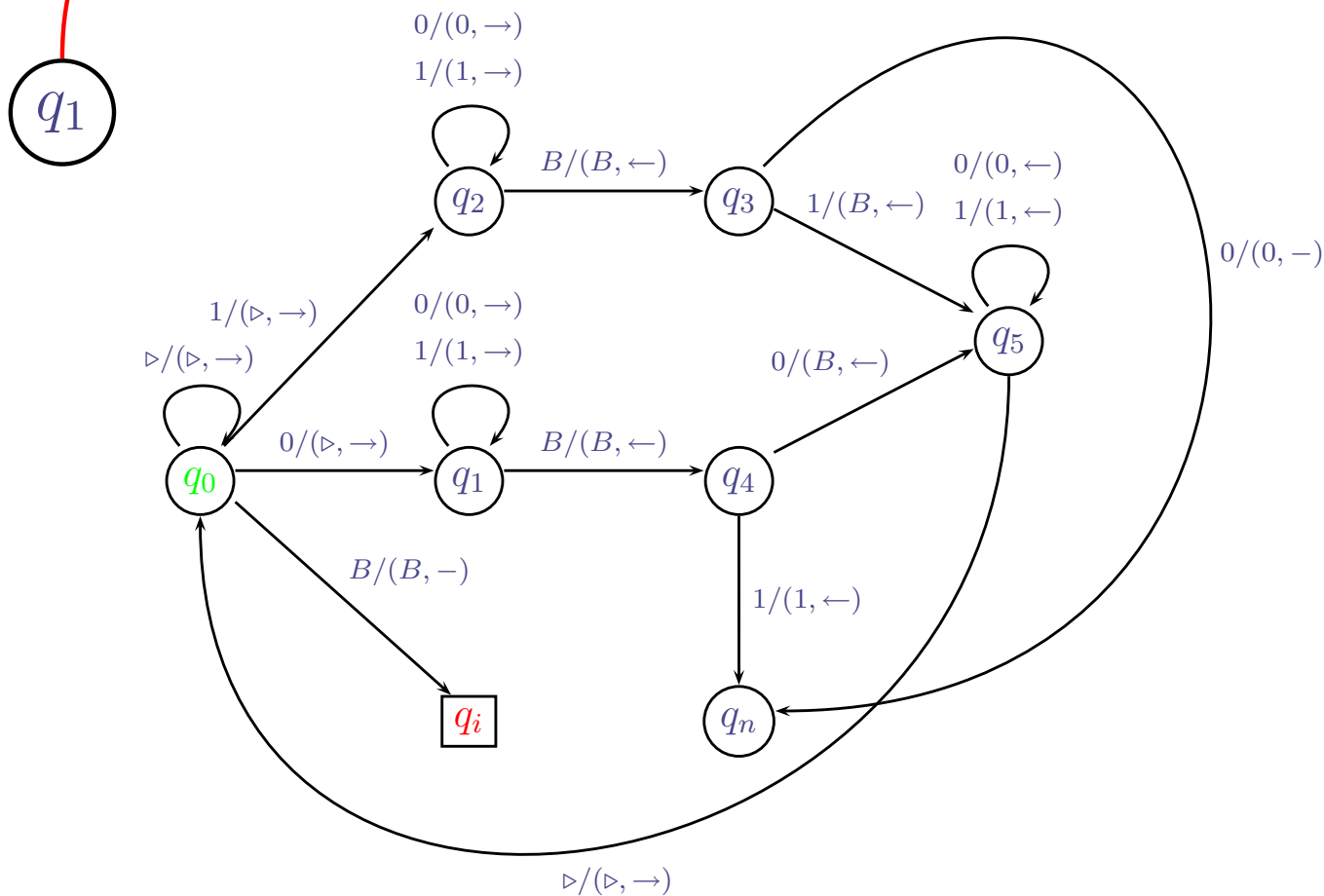

# A páros hosszúságú palindromákat eldöntő Turing-gép

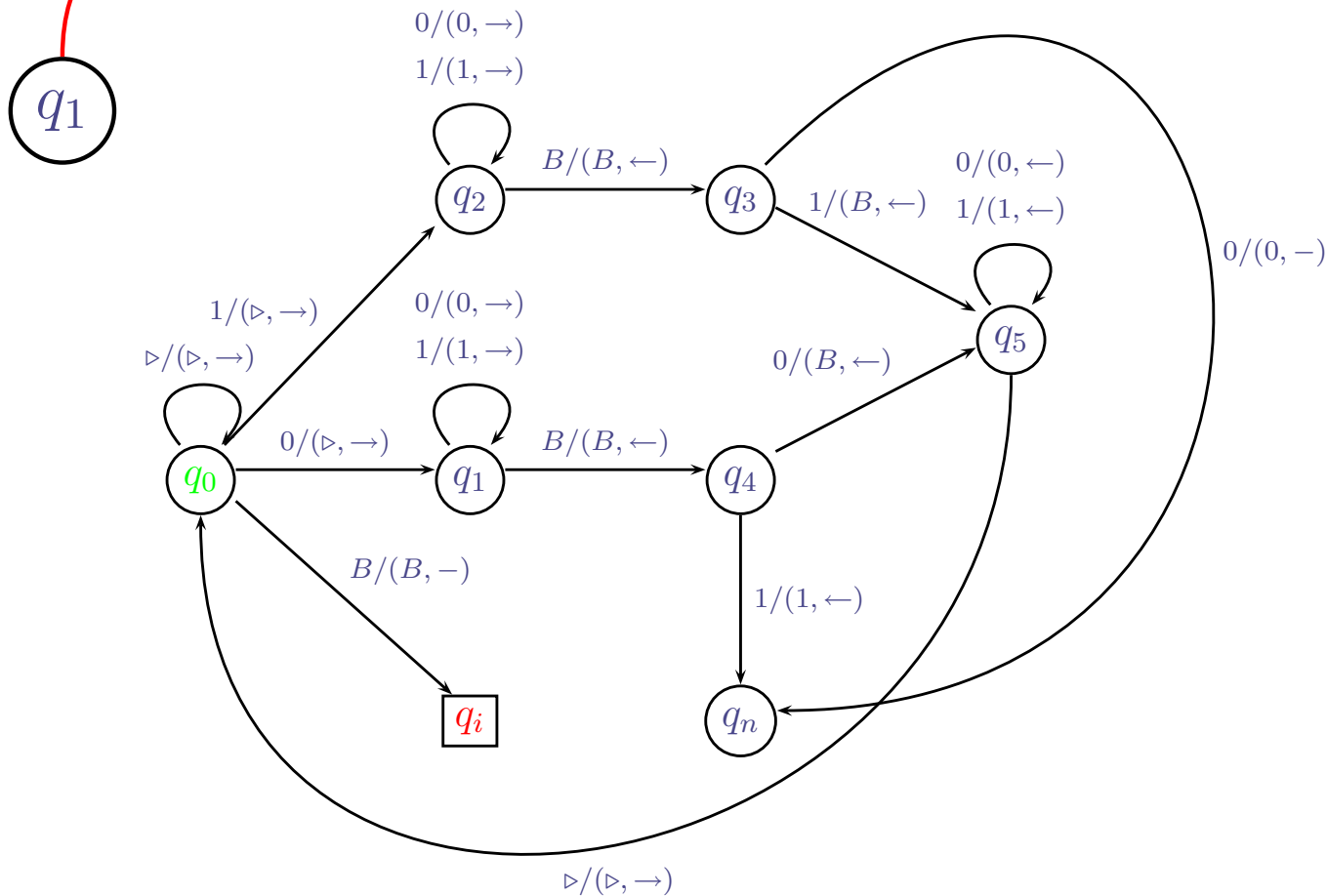



# A páros hosszúságú palindromákat eldöntő Turing-gép

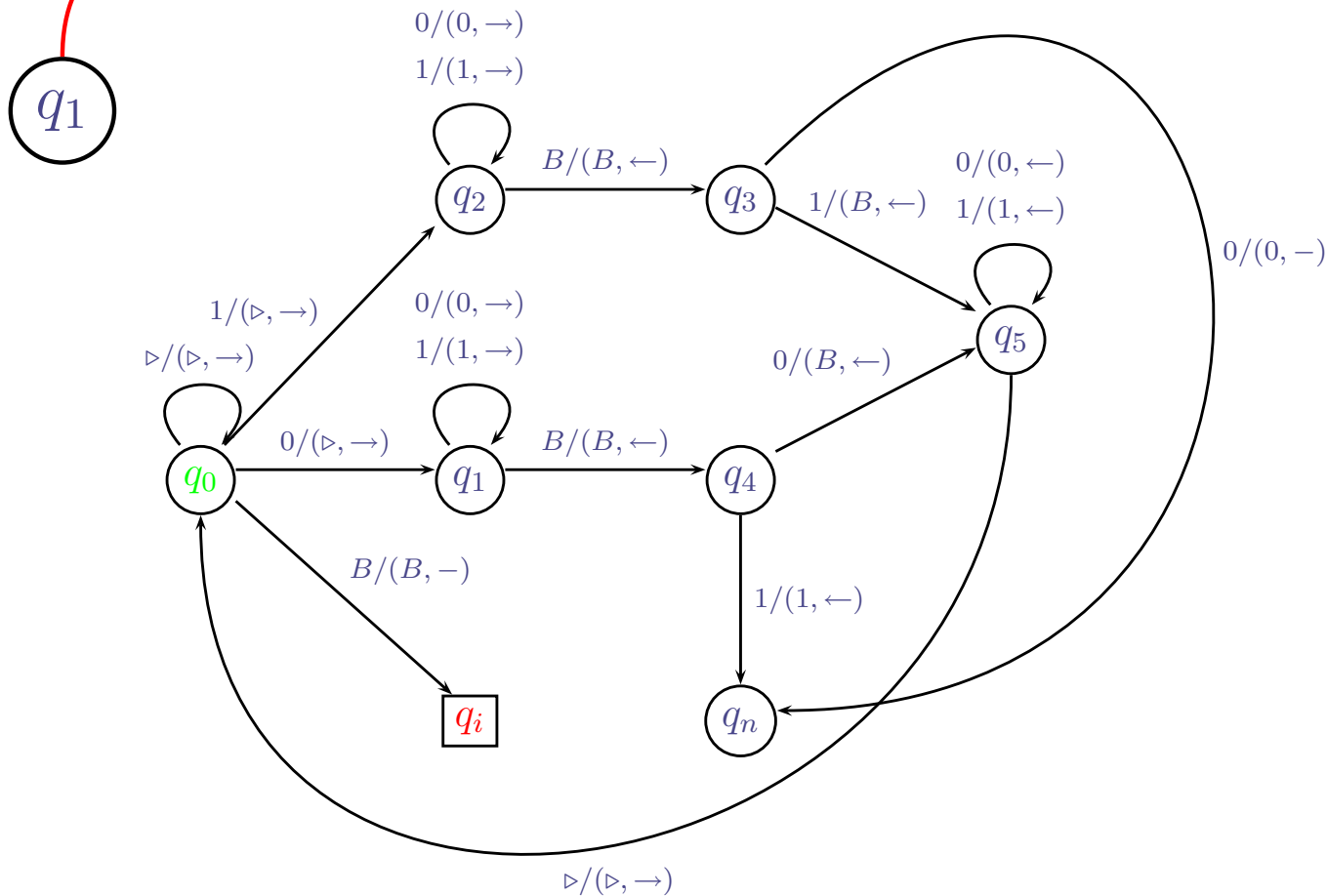

# A páros hosszúságú palindromákat eldöntő Turing-gép

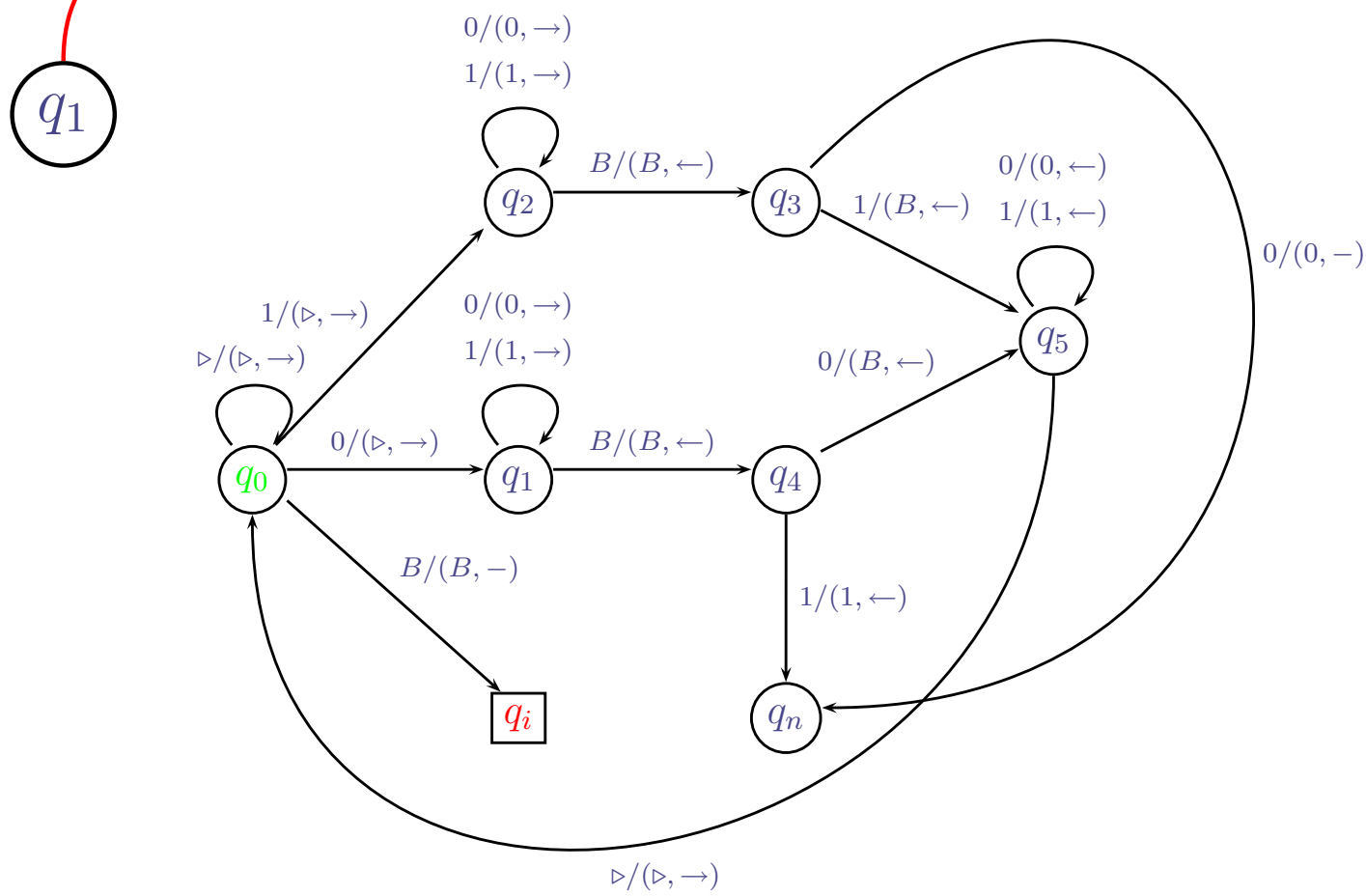

# A páros hosszúságú palindromákat eldöntő Turing-gép

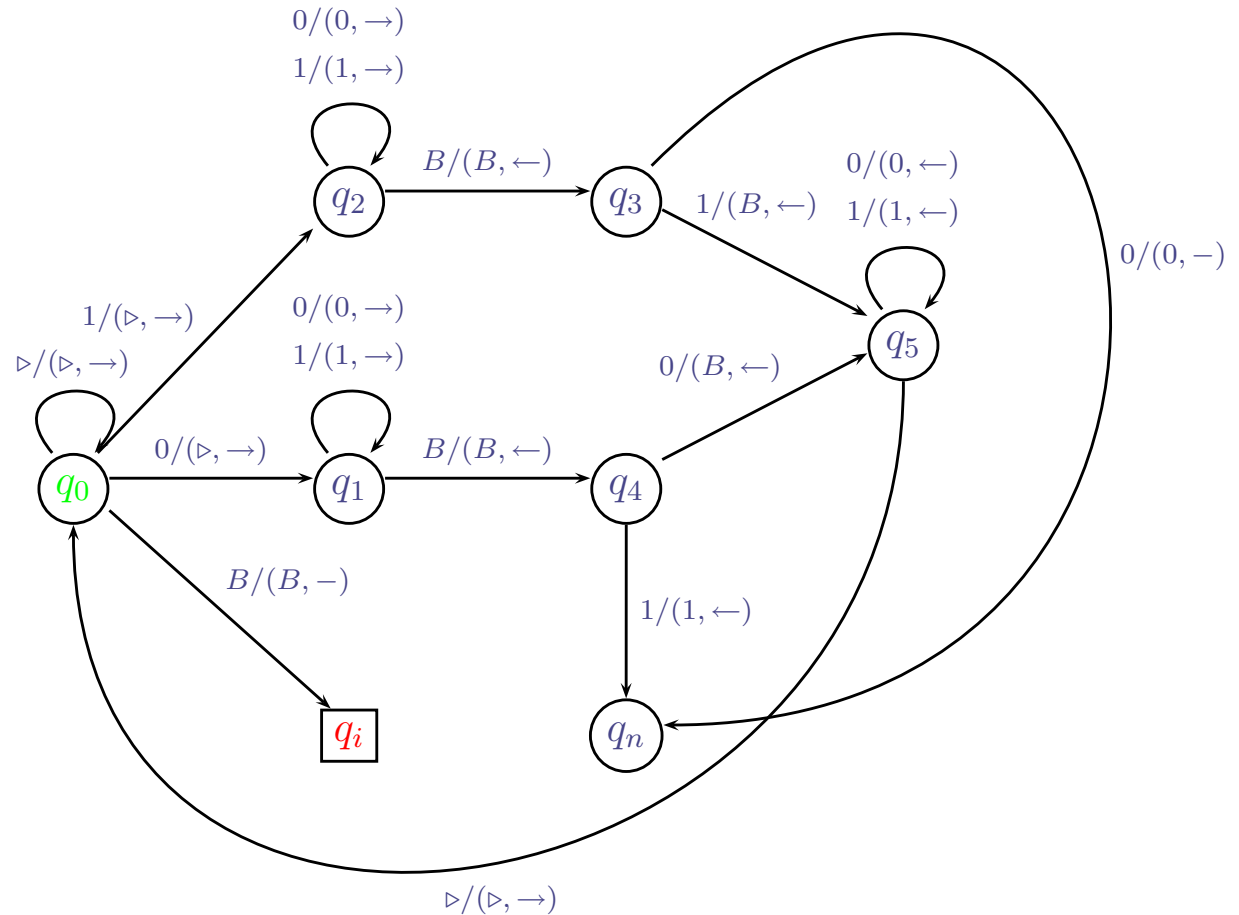

# A páros hosszúságú palindromákat eldöntő Turing-gép

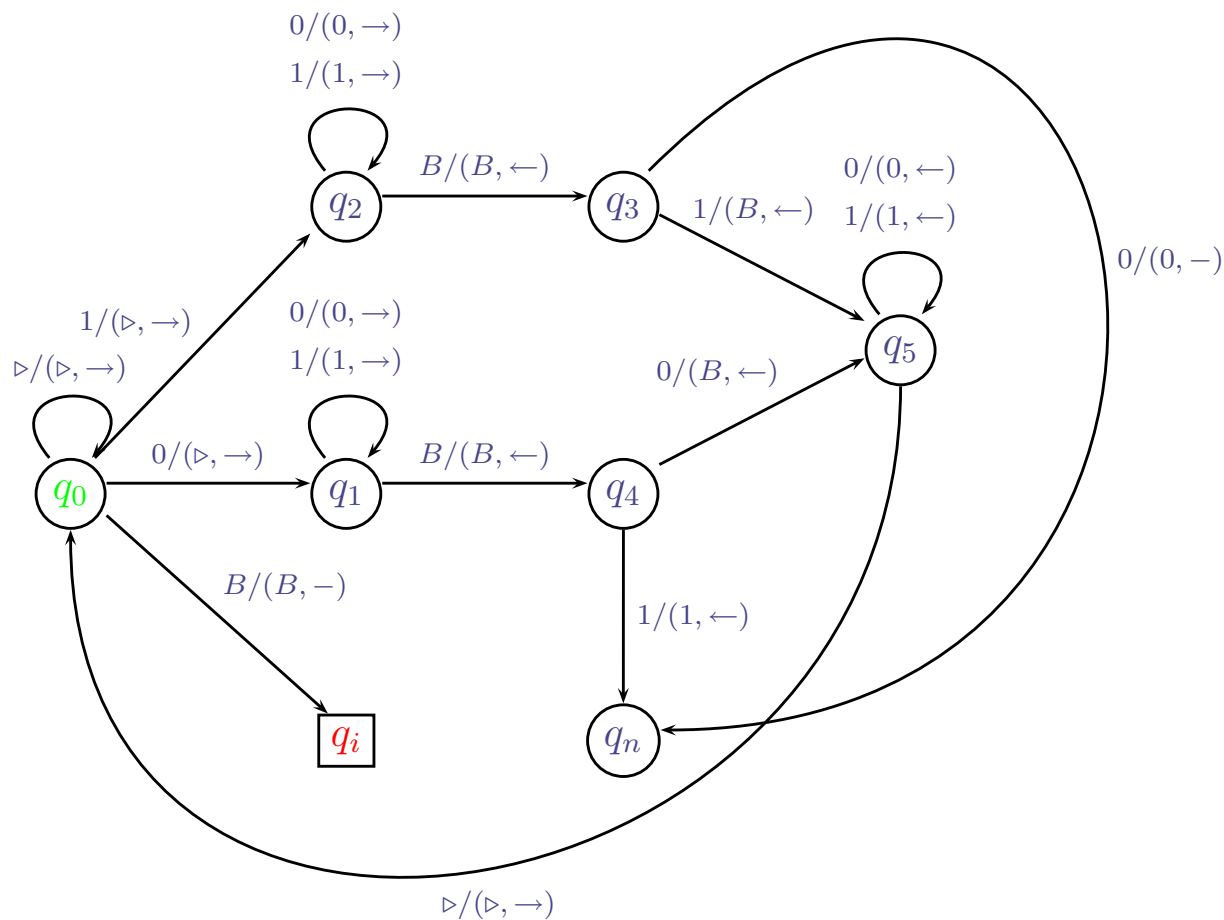
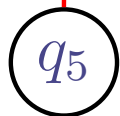

# A páros hosszúságú palindromákat eldöntő Turing-gép

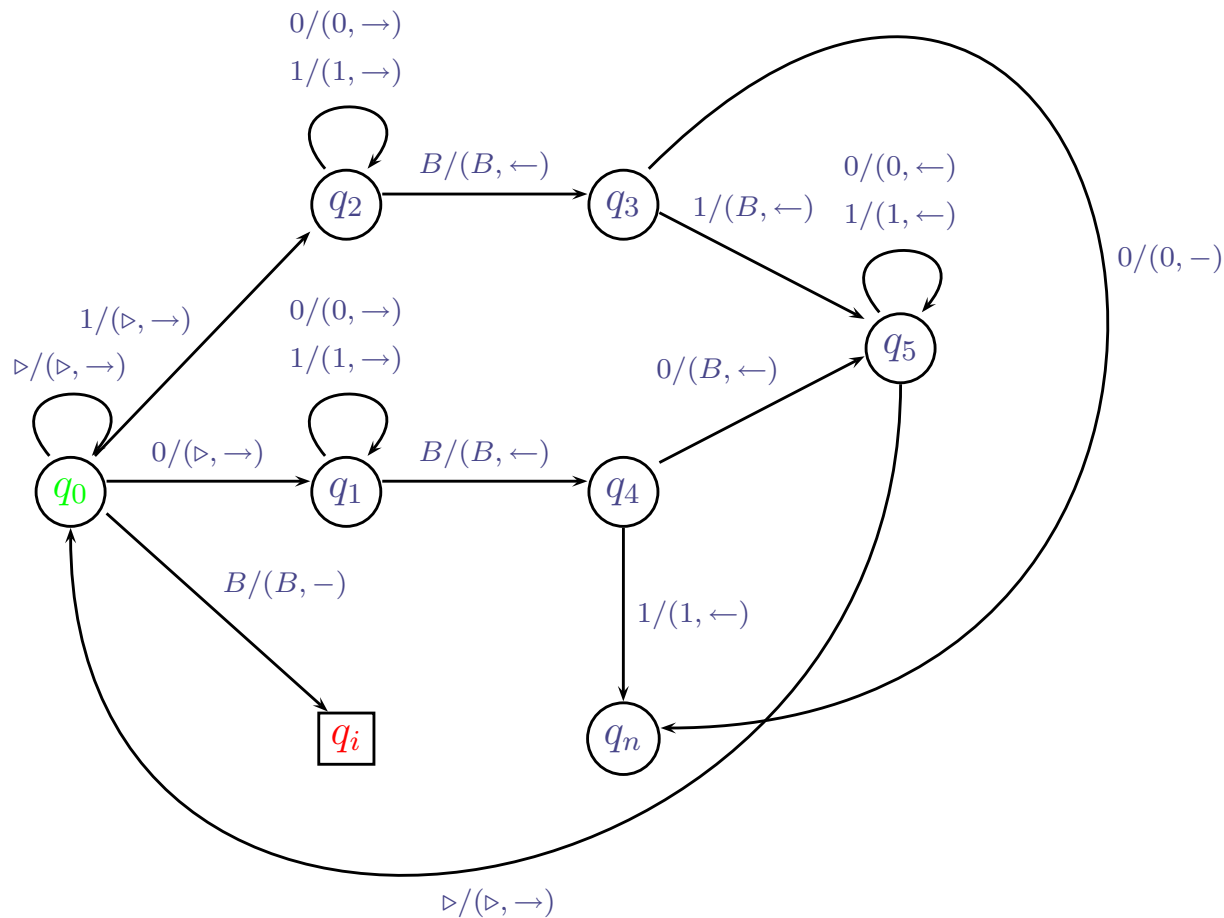
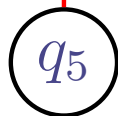
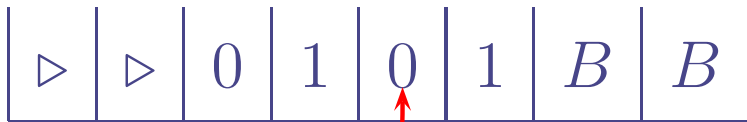

# A páros hosszúságú palindromákat eldöntő Turing-gép

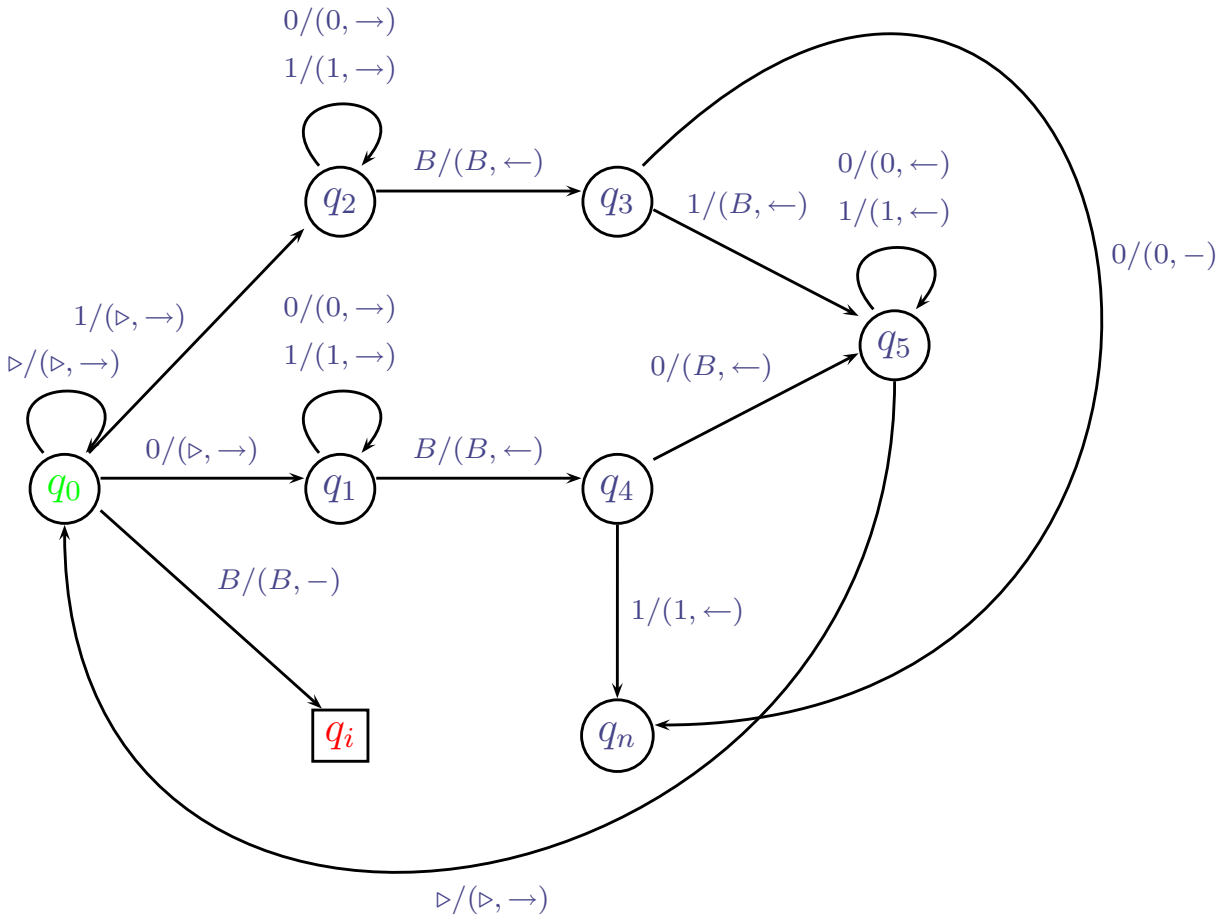
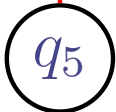

# A páros hosszúságú palindromákat eldöntő Turing-gép

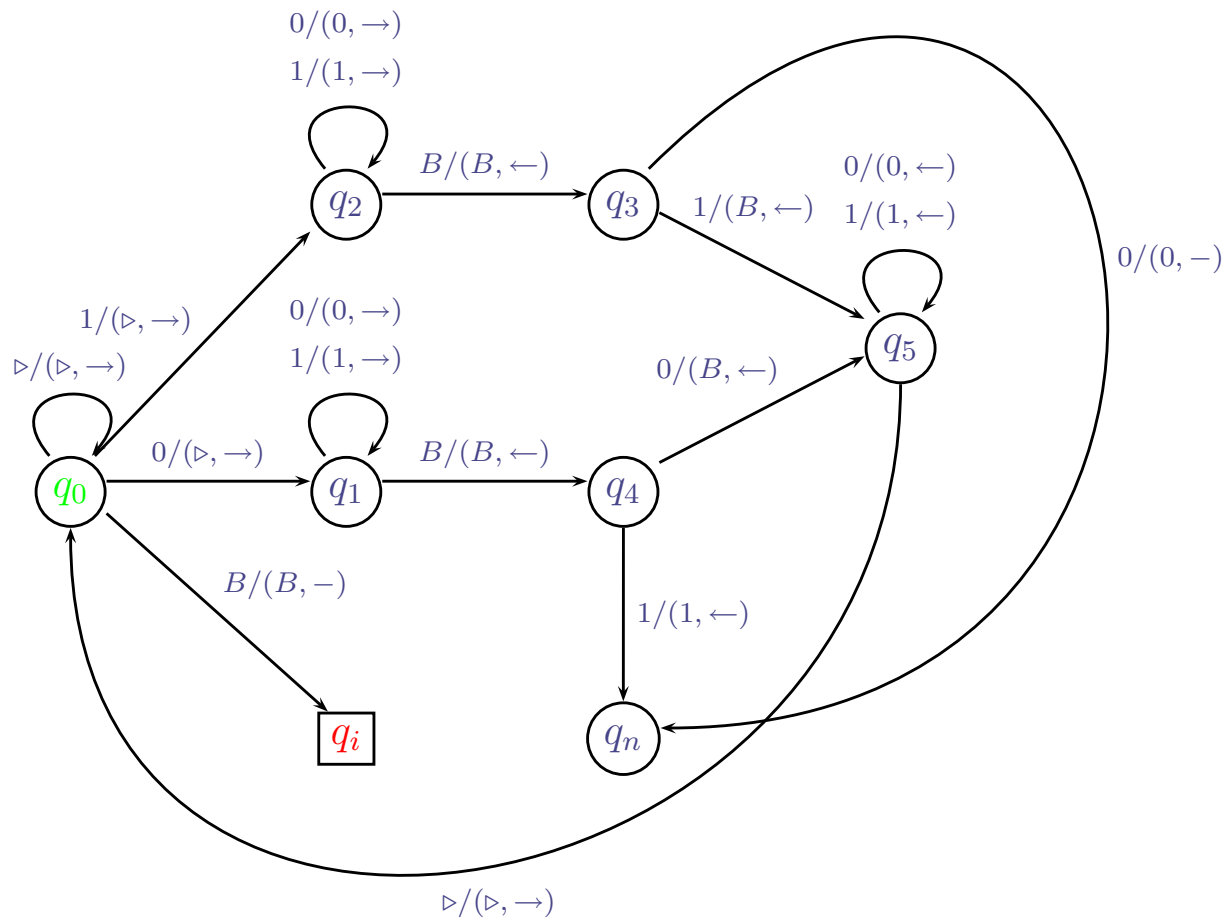
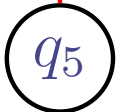

# A páros hosszúságú palindromákat eldöntő Turing-gép

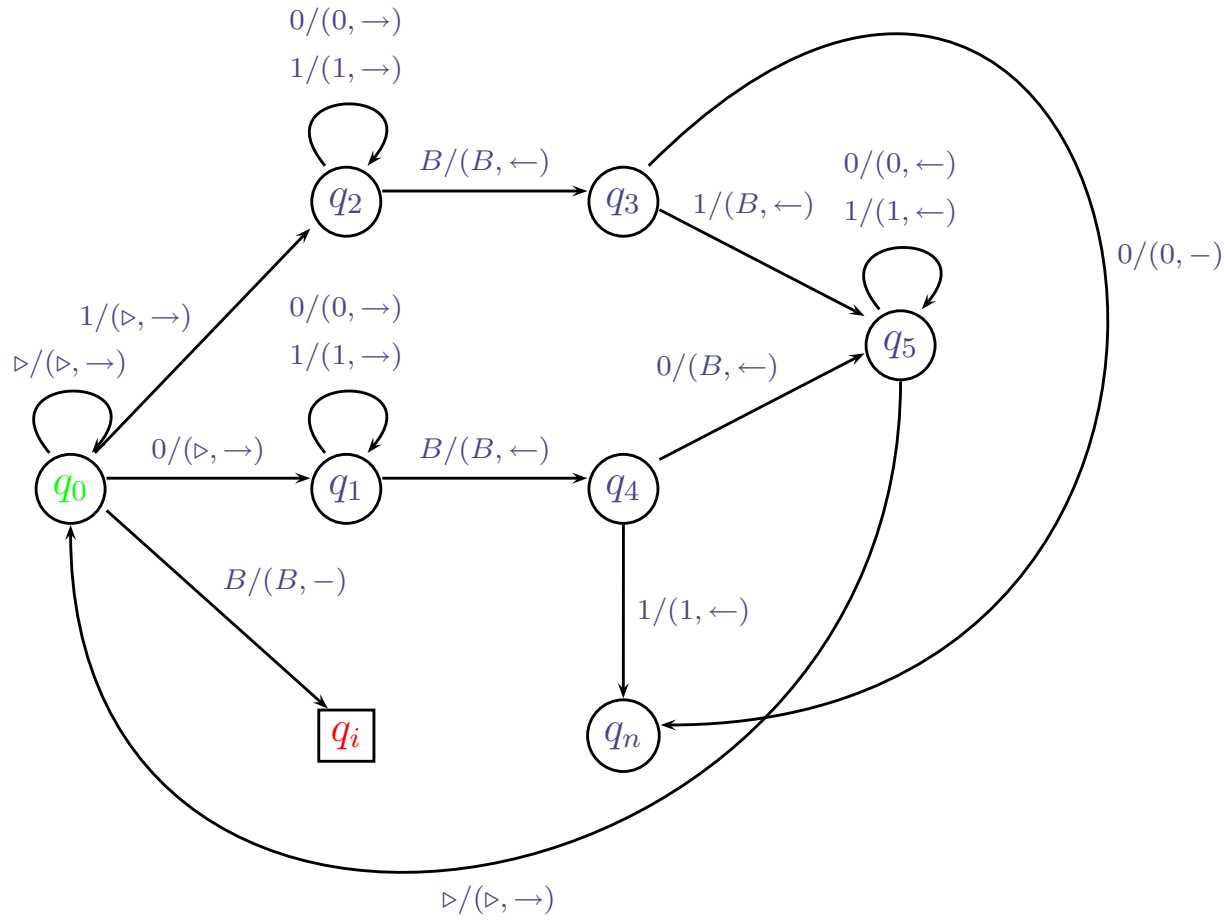
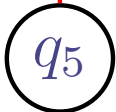



# A páros hosszúságú palindromákat eldöntő Turing-gép

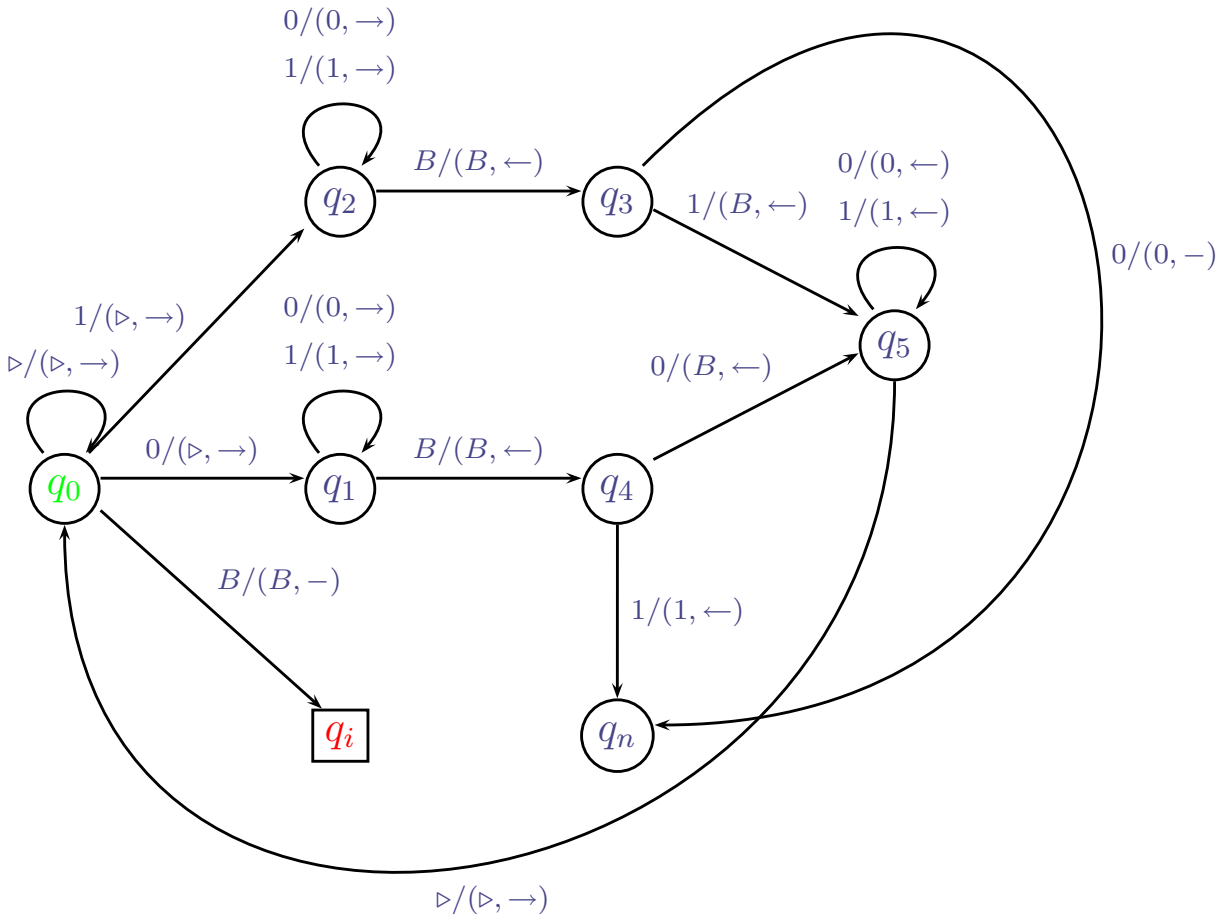
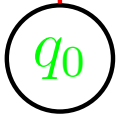

# A páros hosszúságú palindromákat eldöntő Turing-gép

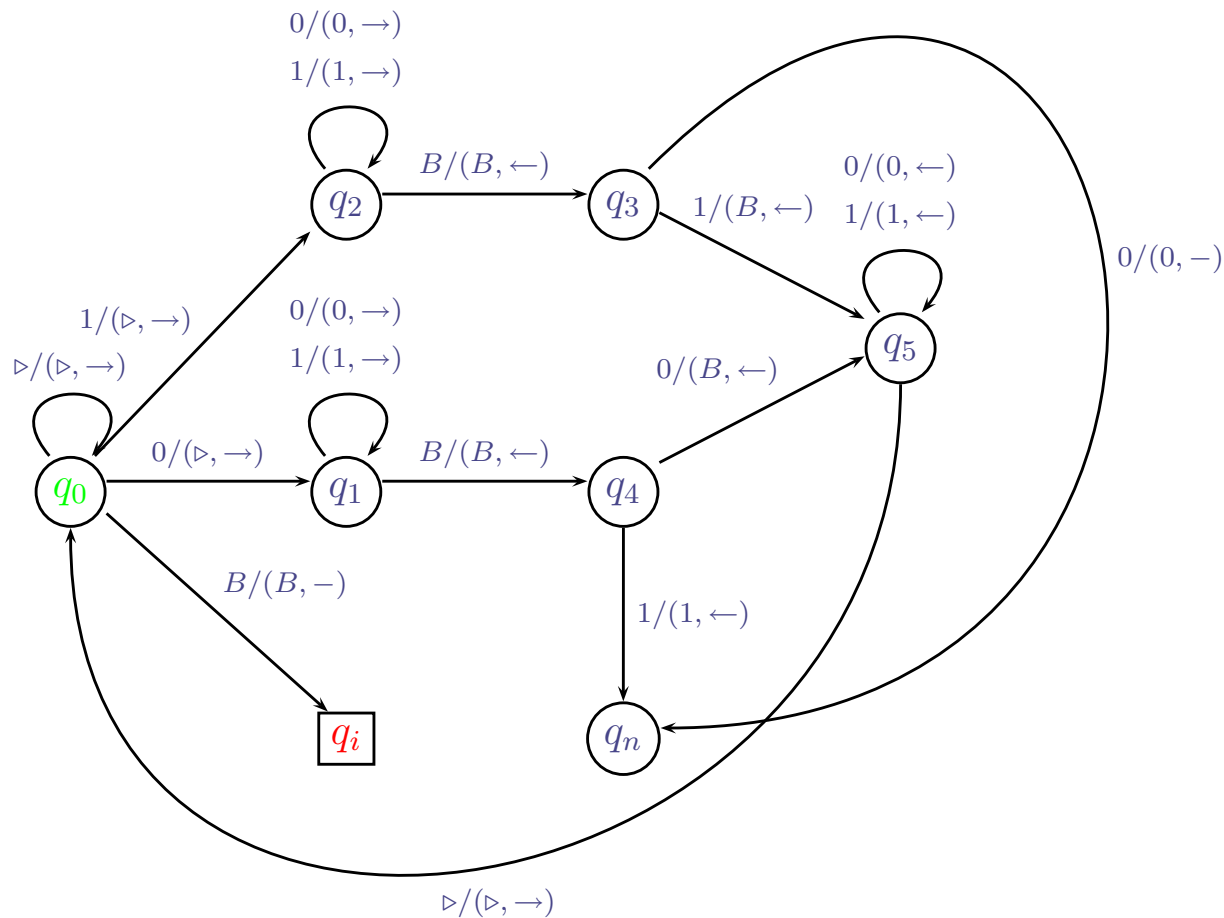
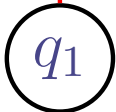

# A páros hosszúságú palindromákat eldöntő Turing-gép

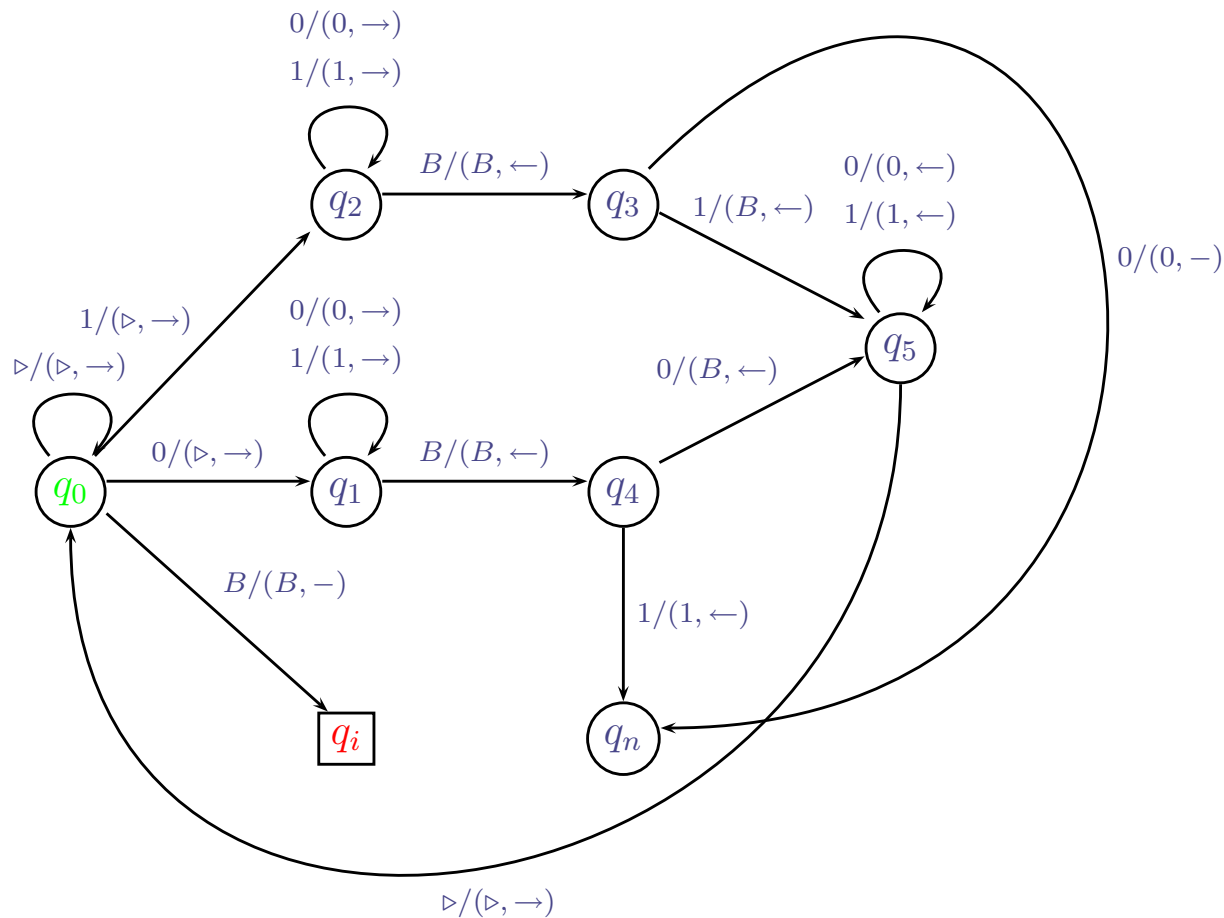
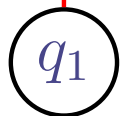
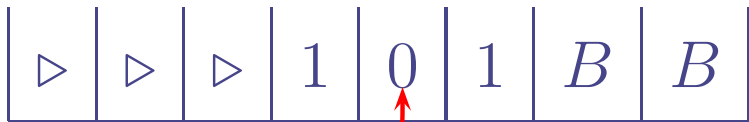

# A páros hosszúságú palindromákat eldöntő Turing-gép

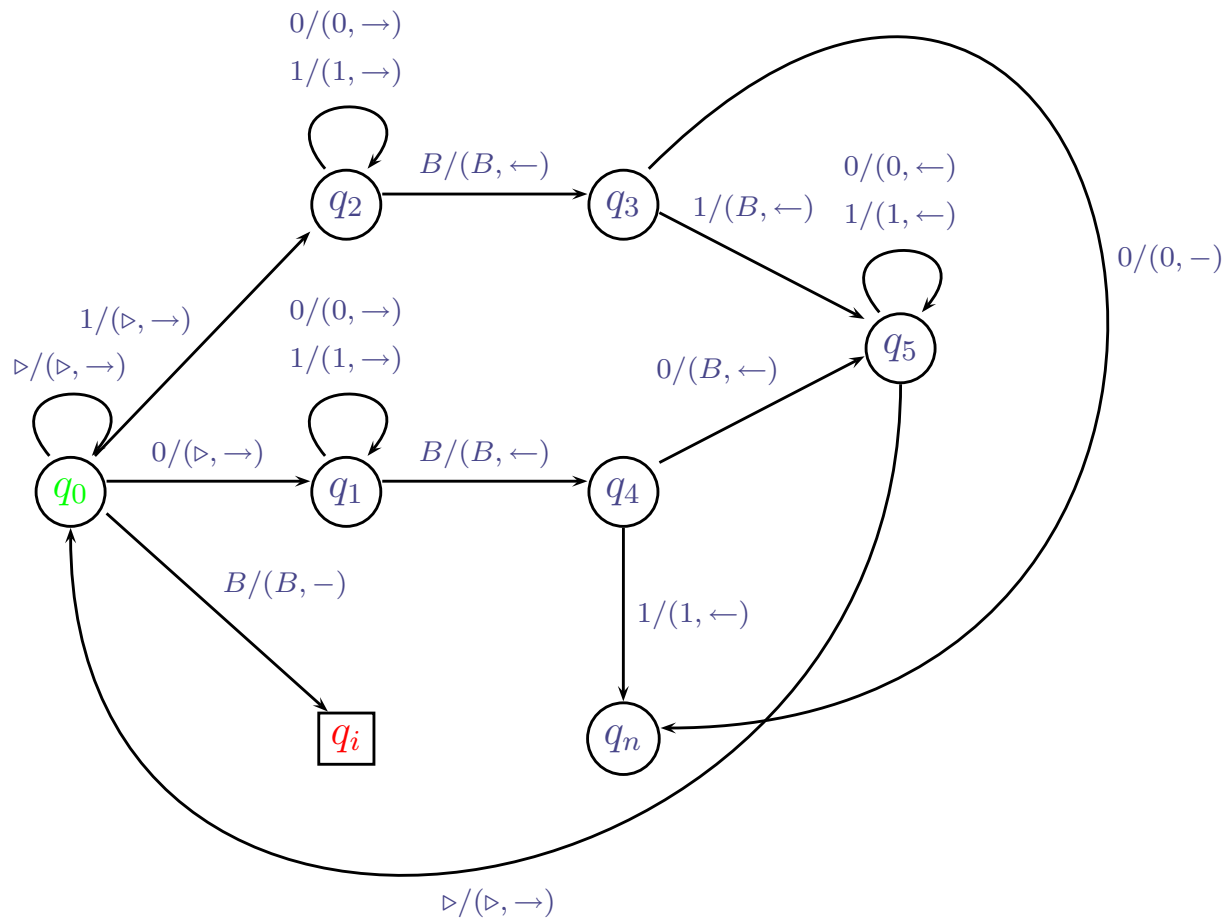
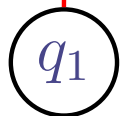

# A páros hosszúságú palindromákat eldöntő Turing-gép

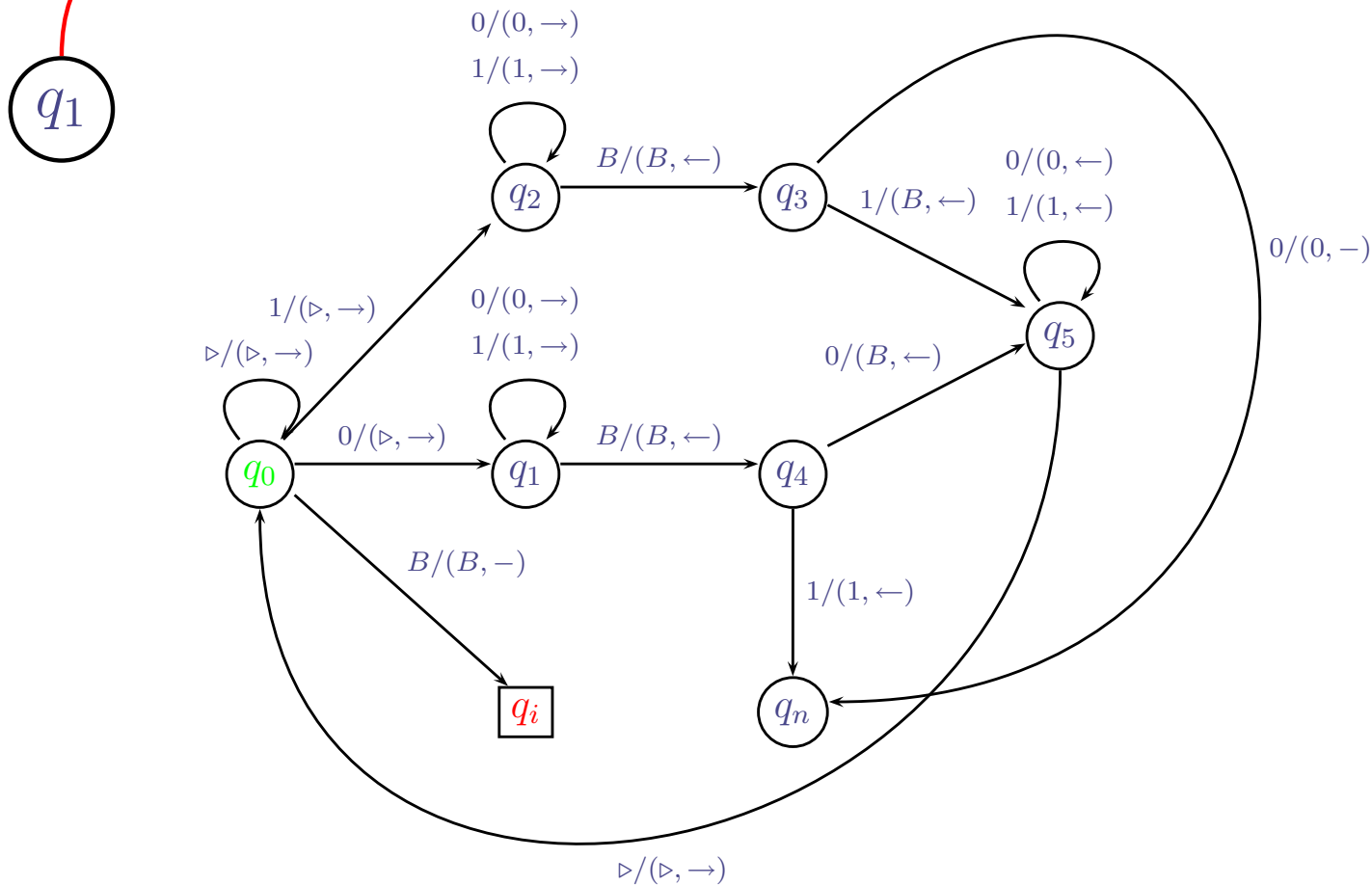

# A páros hosszúságú palindromákat eldöntő Turing-gép

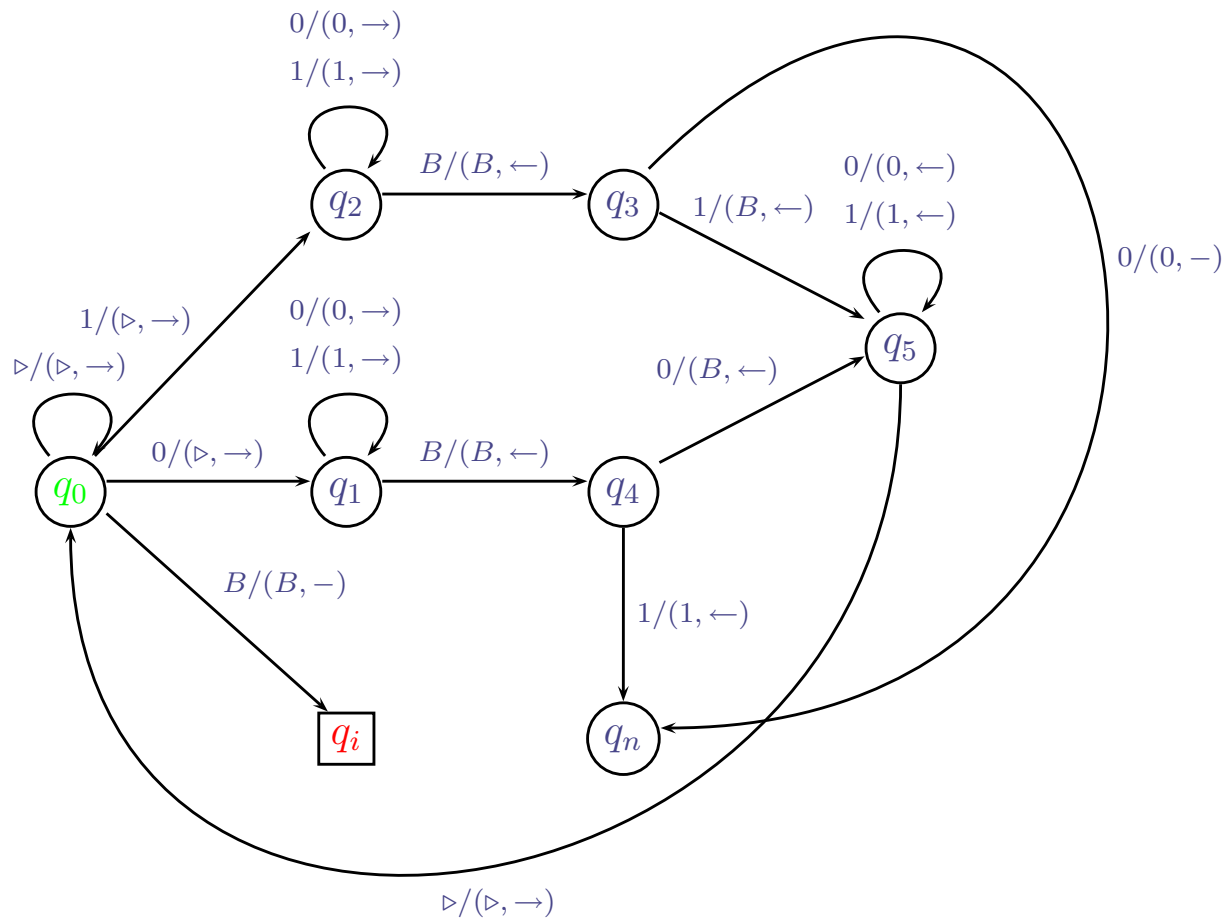

# A páros hosszúságú palindromákat eldöntő Turing-gép

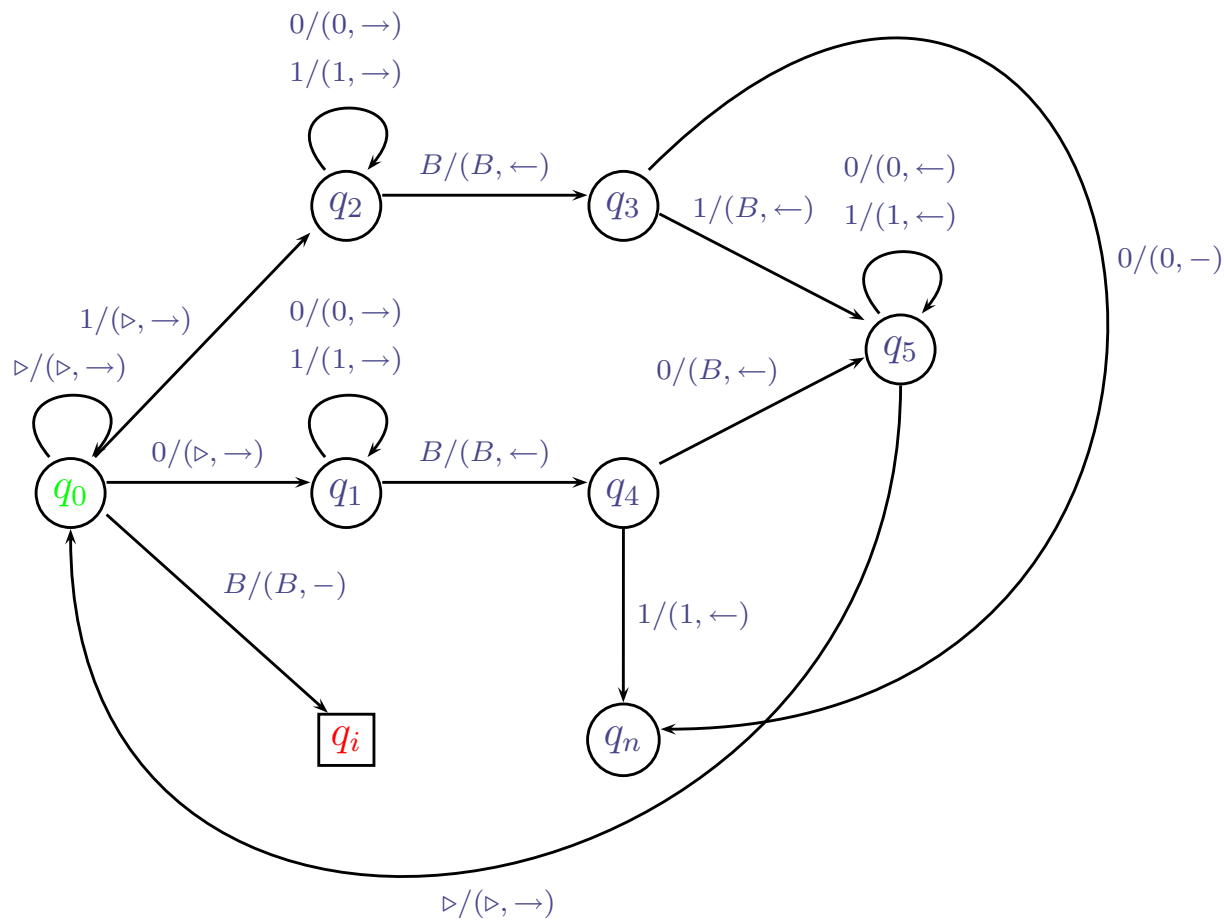
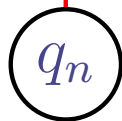

# A palindromákat eldöntő 2-szavas T-gép

$\langle \triangleright, \triangleright \rangle / (\langle \triangleright, \triangleright \rangle, \langle \rightarrow, \rightarrow \rangle)$

$\langle 0, B \rangle / (\langle 0, 0 \rangle, \langle \rightarrow, \rightarrow \rangle)$

$\langle 1, B \rangle / (\langle 1, 1 \rangle, \langle \rightarrow, \rightarrow \rangle)$

$\langle 0, B \rangle / (\langle 0, B \rangle, \langle \leftarrow, - \rangle)$

$\langle 1, B \rangle / (\langle 1, B \rangle, \langle \leftarrow, - \rangle)$

$\langle 0, 0 \rangle / (\langle 0, 0 \rangle, \langle \rightarrow, \leftarrow \rangle)$

$\langle 1, 1 \rangle / (\langle 1, 1 \rangle, \langle \rightarrow, \leftarrow \rangle)$

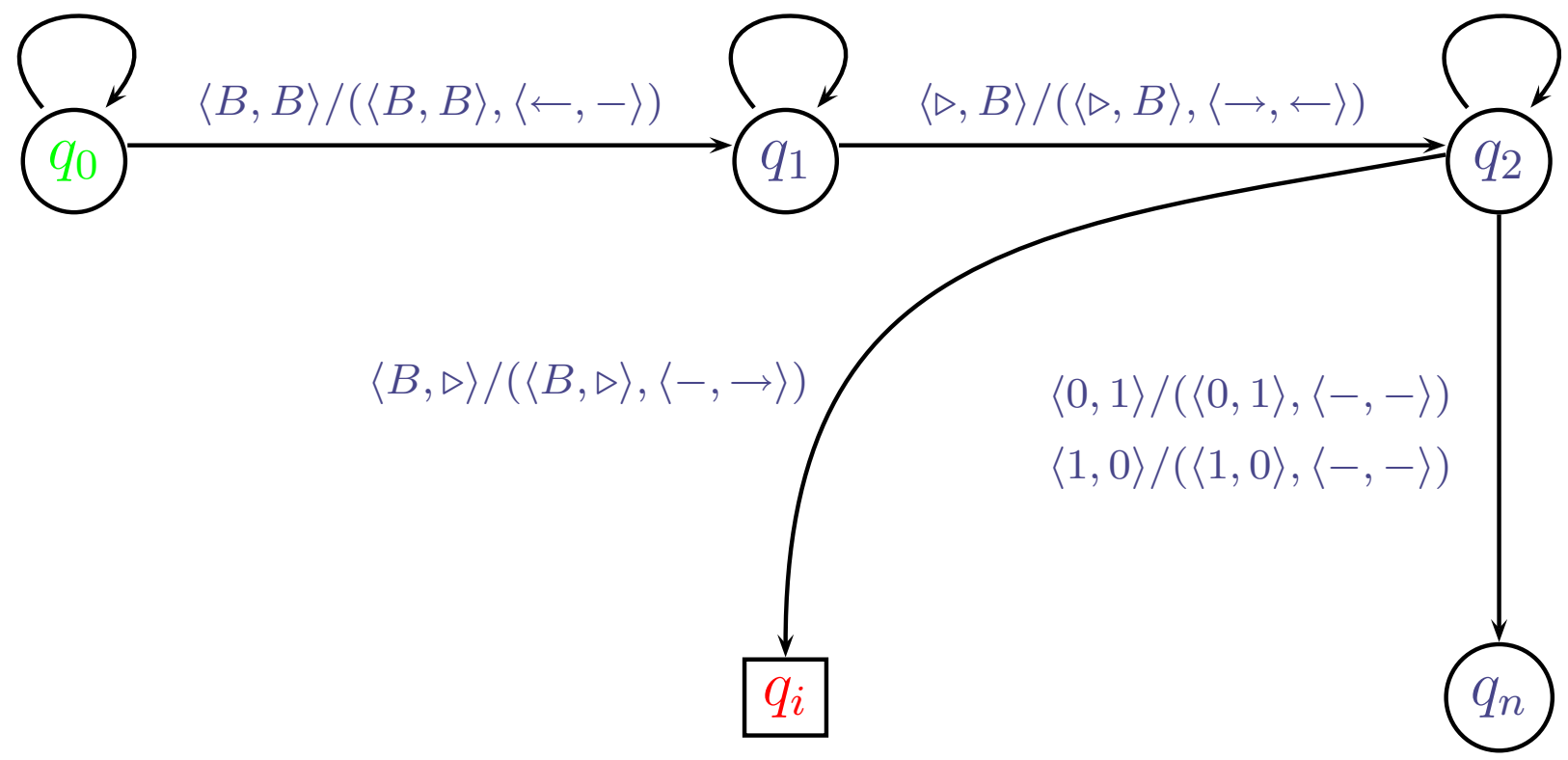



# A palindromákat eldöntő 2-szavas T-gép

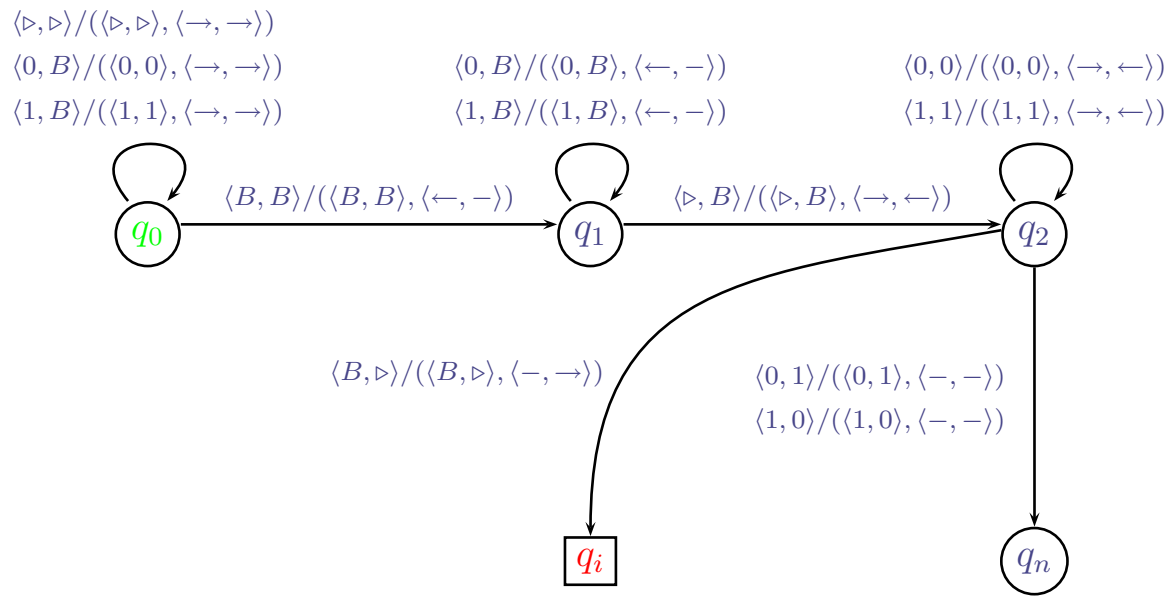
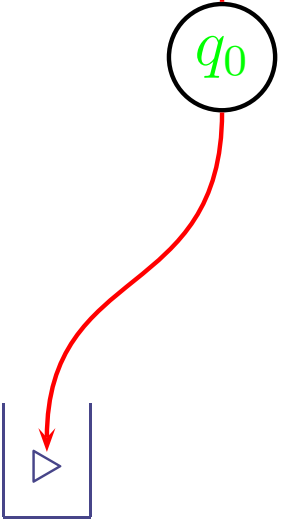

# A palindromákat eldöntő 2-szavas T-gép

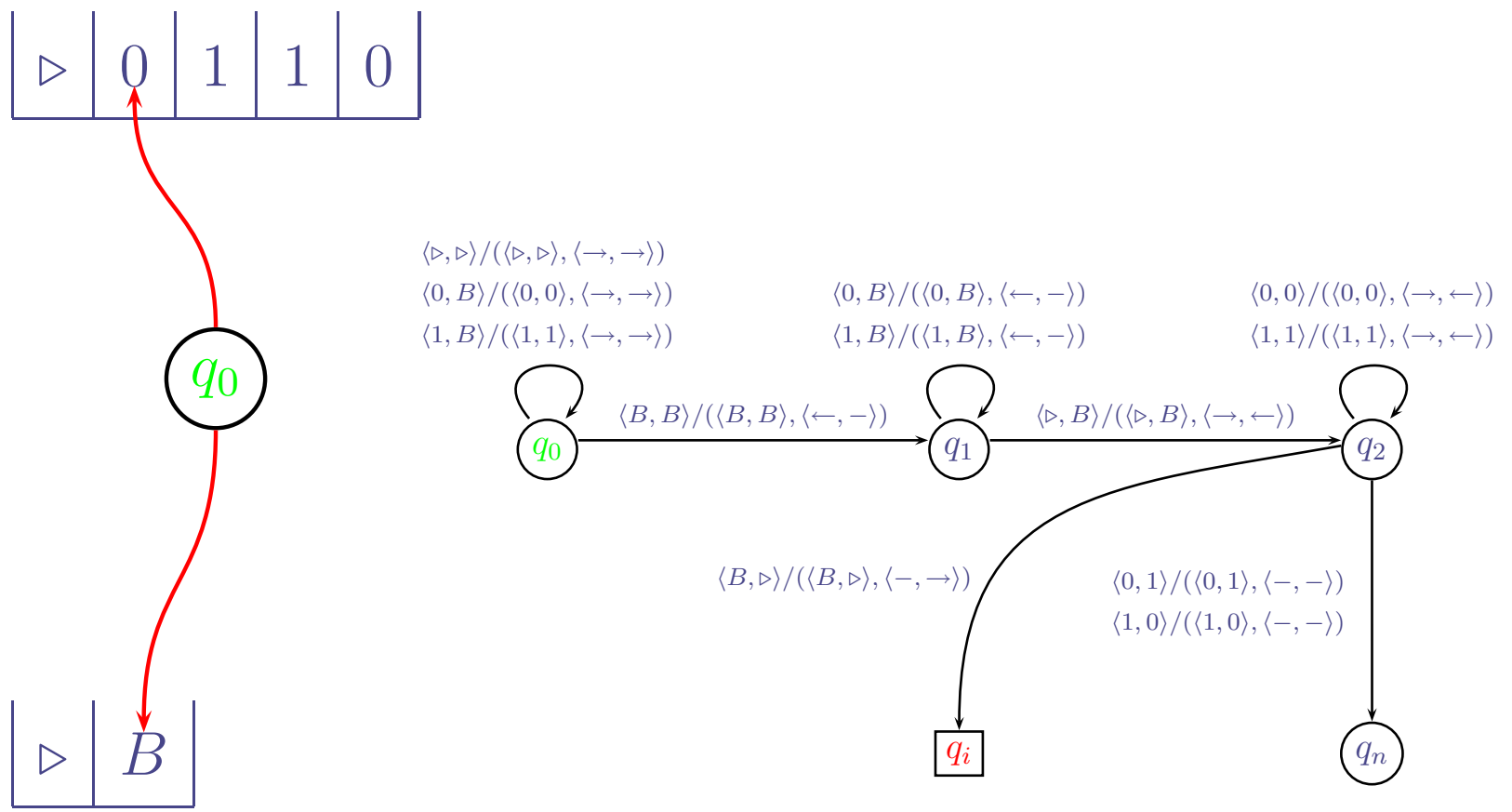

# A palindromákat eldöntő 2-szavas T-gép

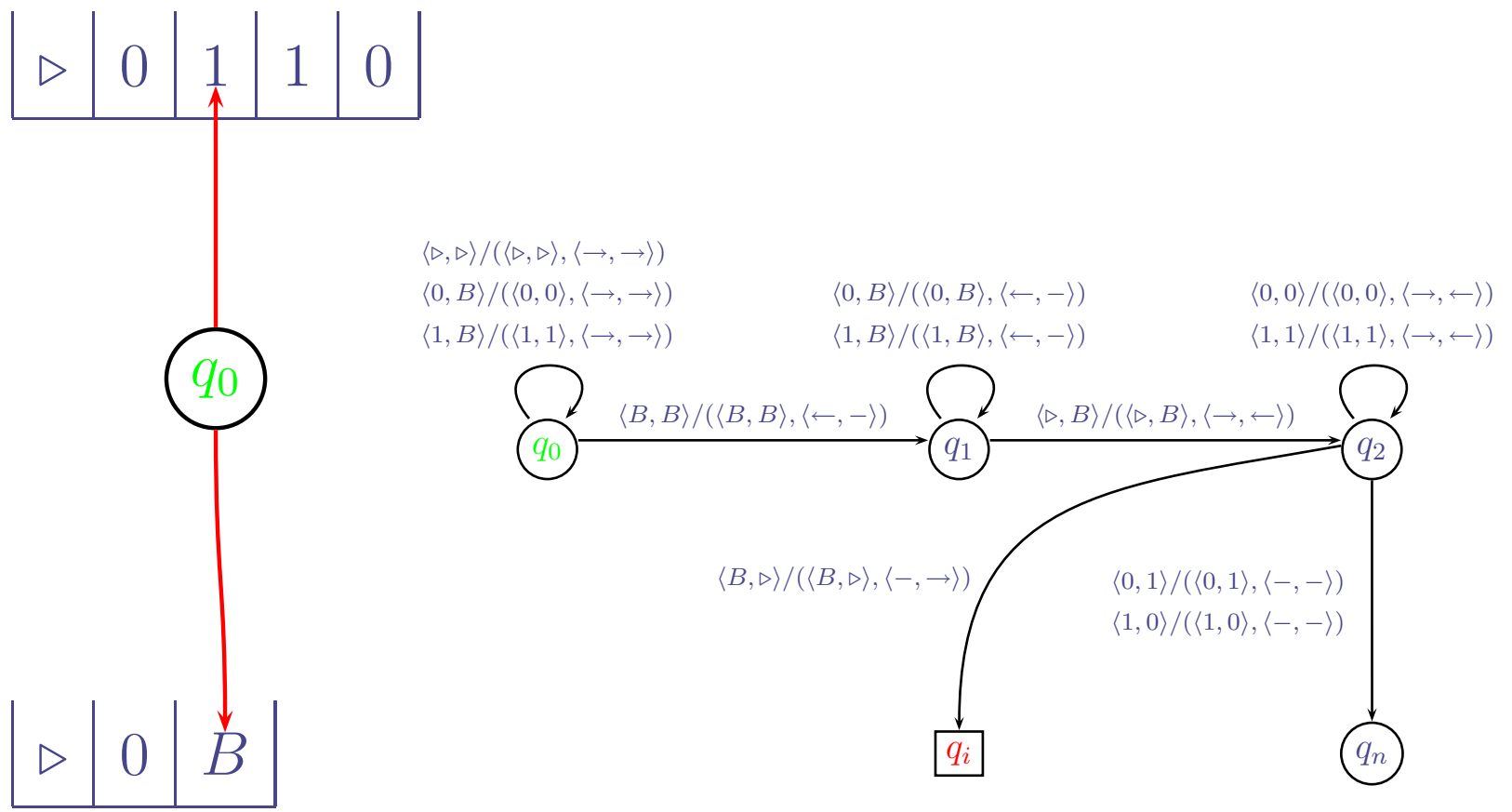

# A palindromákat eldöntő 2-szavas T-gép

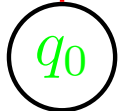

- $\langle \triangleright, \triangleright \rangle / (\langle \triangleright, \triangleright \rangle, \langle \rightarrow, \rightarrow \rangle)$
- $\langle 0, B \rangle / (\langle 0, 0 \rangle, \langle \rightarrow, \rightarrow \rangle)$
- $\langle 1, B \rangle / (\langle 1, 1 \rangle, \langle \rightarrow, \rightarrow \rangle)$
- $\langle 0, B \rangle / (\langle 0, B \rangle, \langle \leftarrow, - \rangle)$
- $\langle 1, B \rangle / (\langle 1, B \rangle, \langle \leftarrow, - \rangle)$
- $\langle 0, 0 \rangle / (\langle 0, 0 \rangle, \langle \rightarrow, \leftarrow \rangle)$
- $\langle 1, 1 \rangle / (\langle 1, 1 \rangle, \langle \rightarrow, \leftarrow \rangle)$

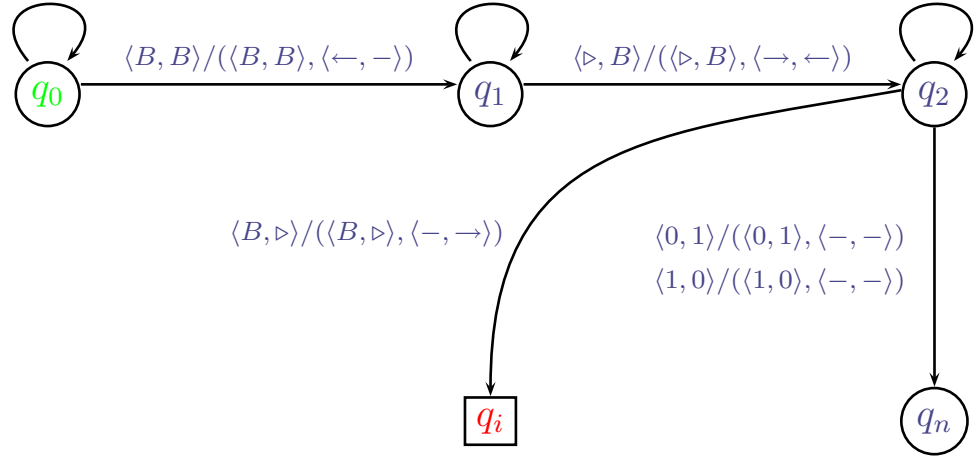

# A palindromákat eldöntő 2-szavas T-gép

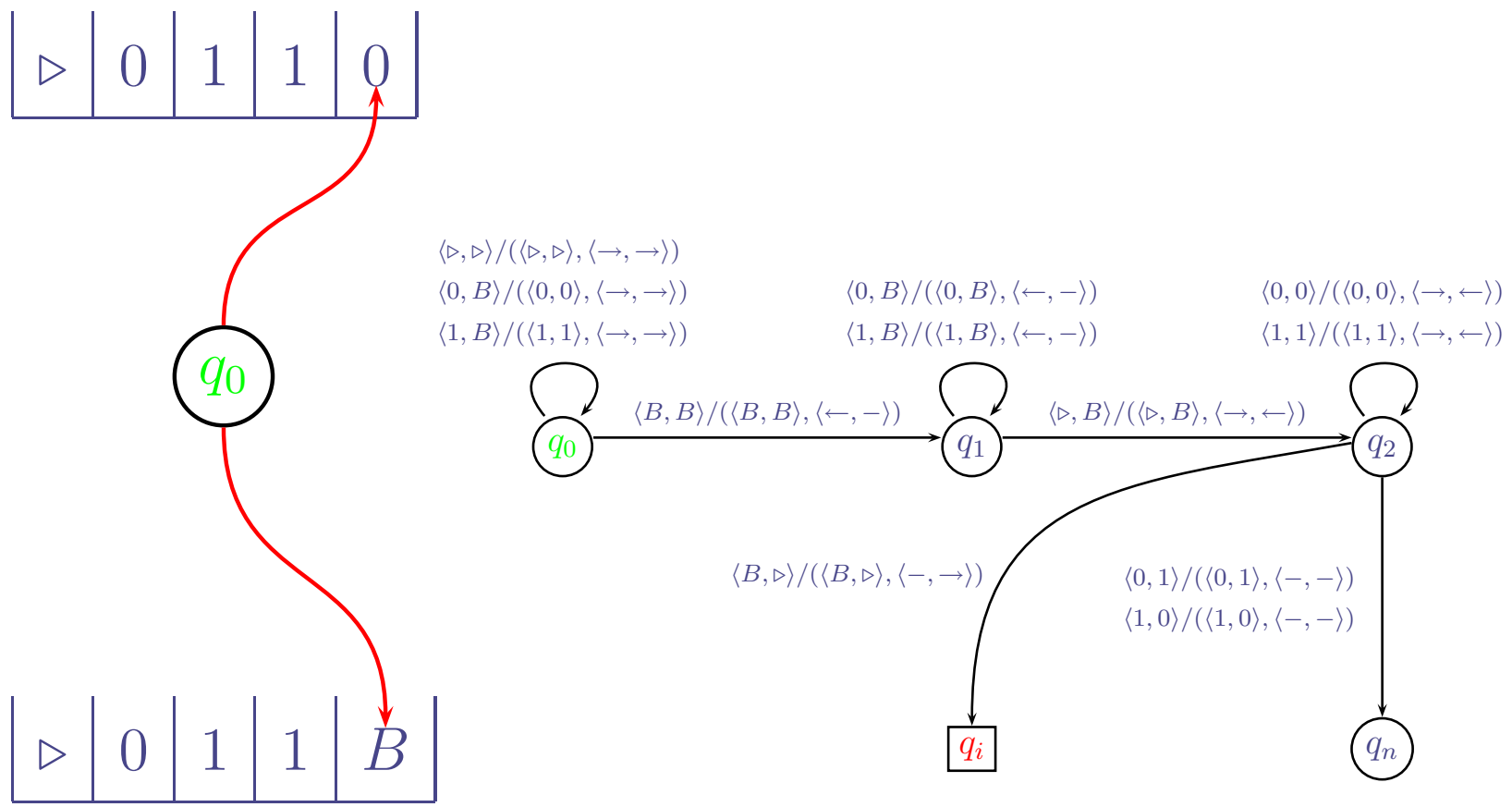

# A palindromákat eldöntő 2-szavas T-gép

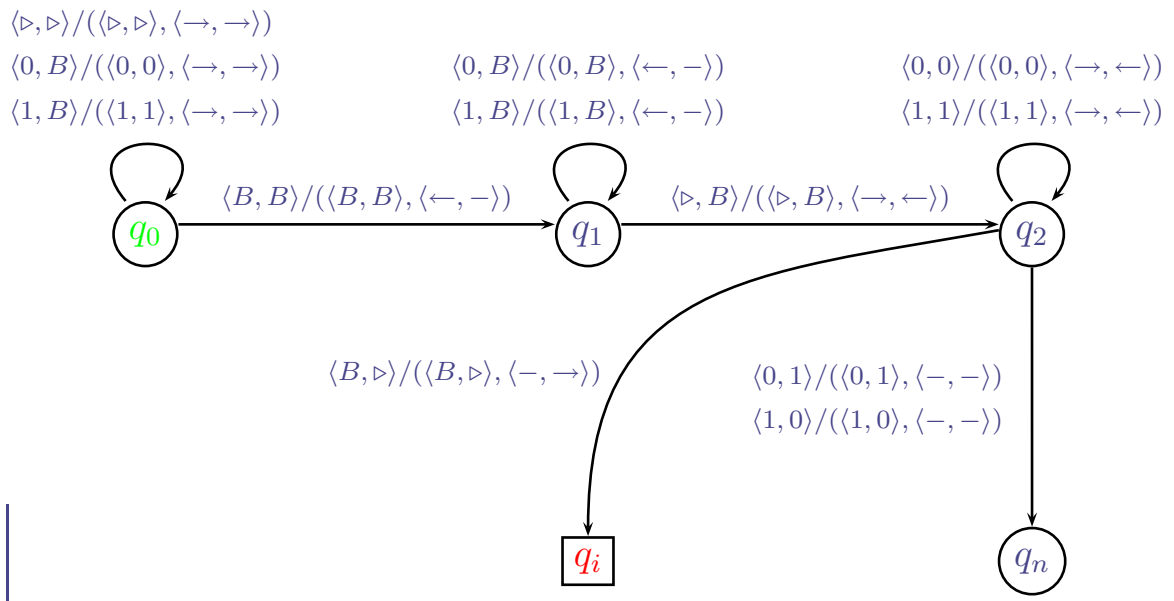
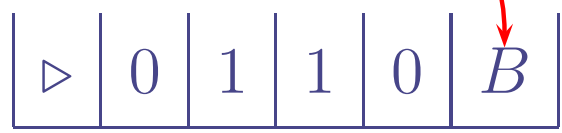
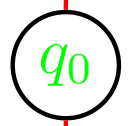

# A palindromákat eldöntő 2-szavas T-gép

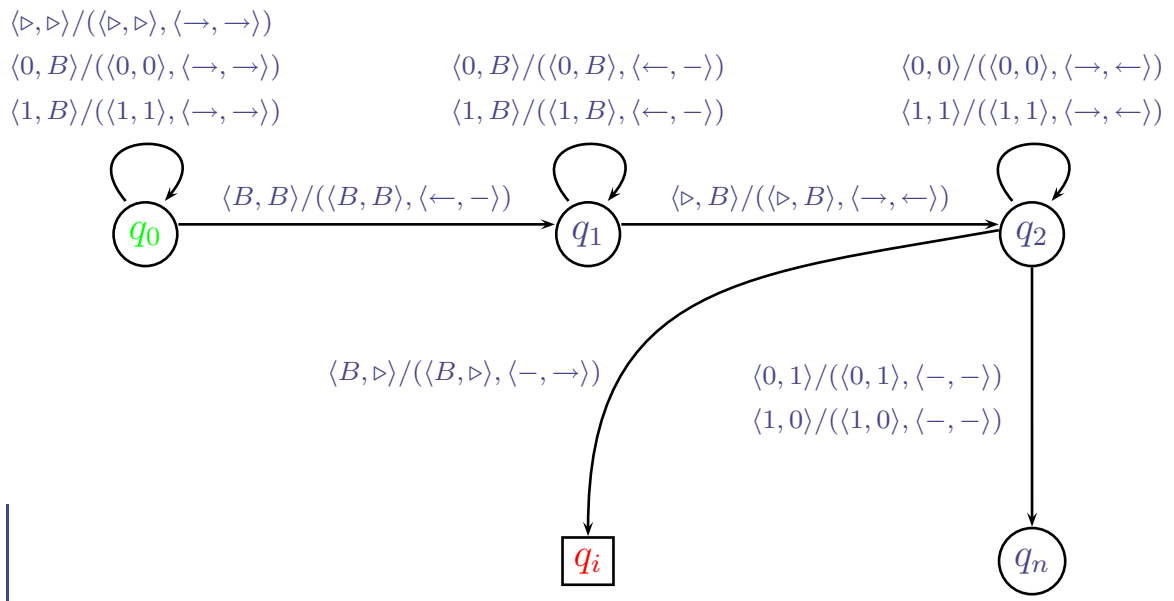
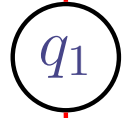

# A palindromákat eldöntő 2-szavas T-gép

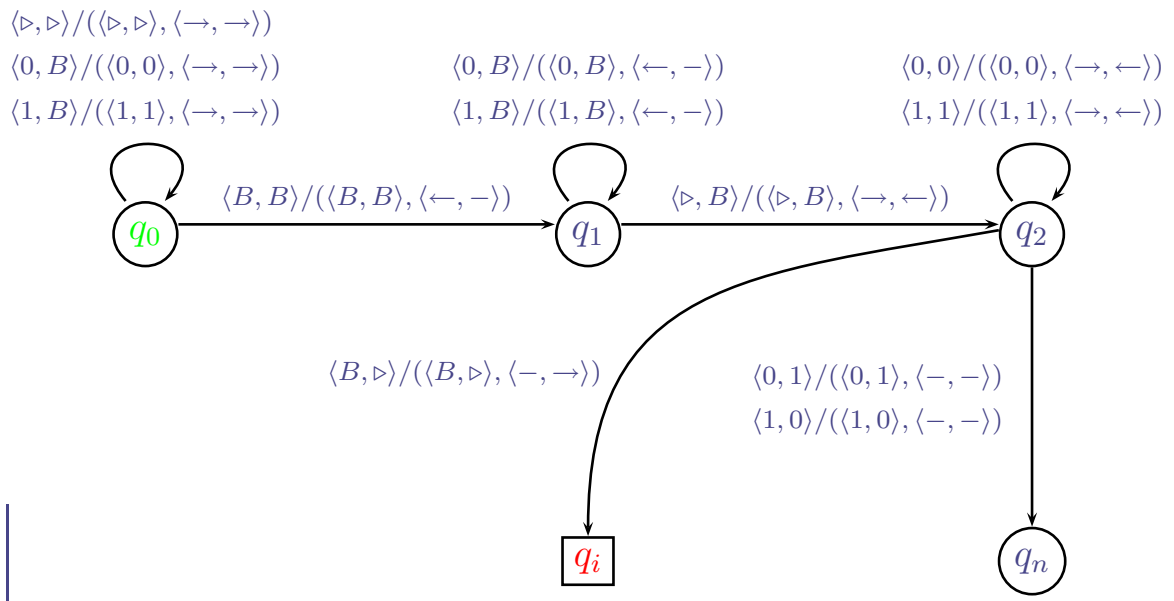
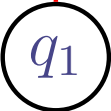
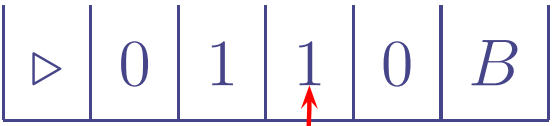



# A palindromákat eldöntő 2-szavas T-gép

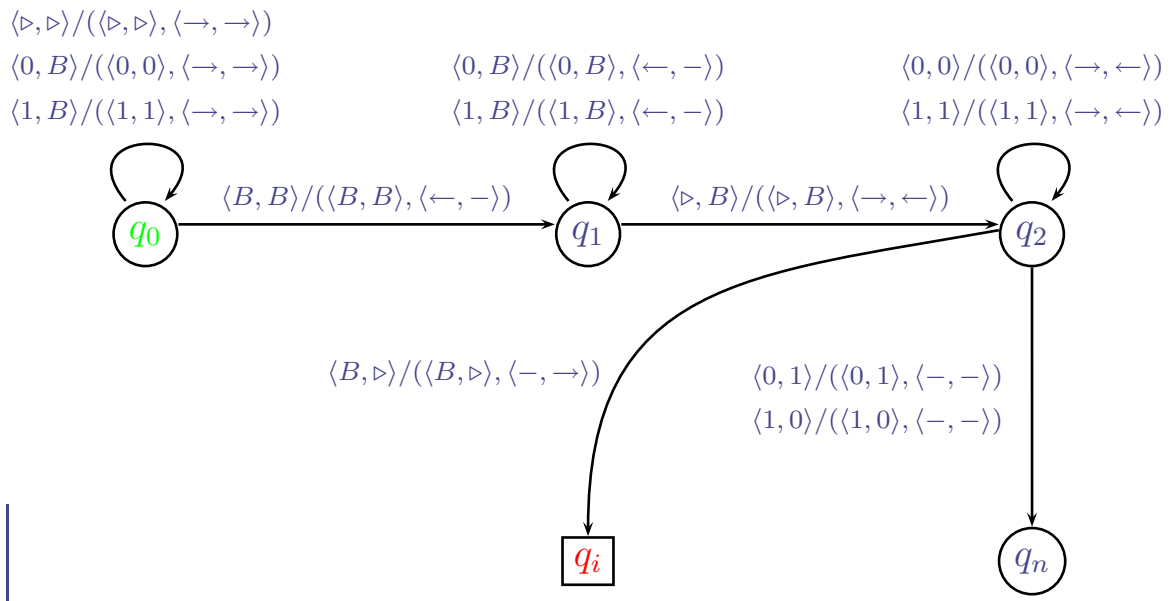
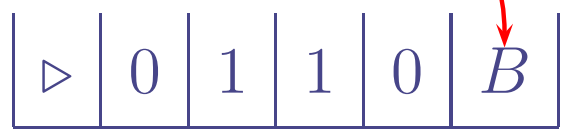
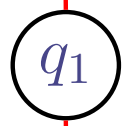
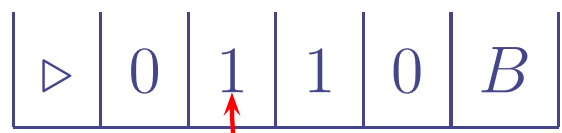

# A palindromákat eldöntő 2-szavas T-gép

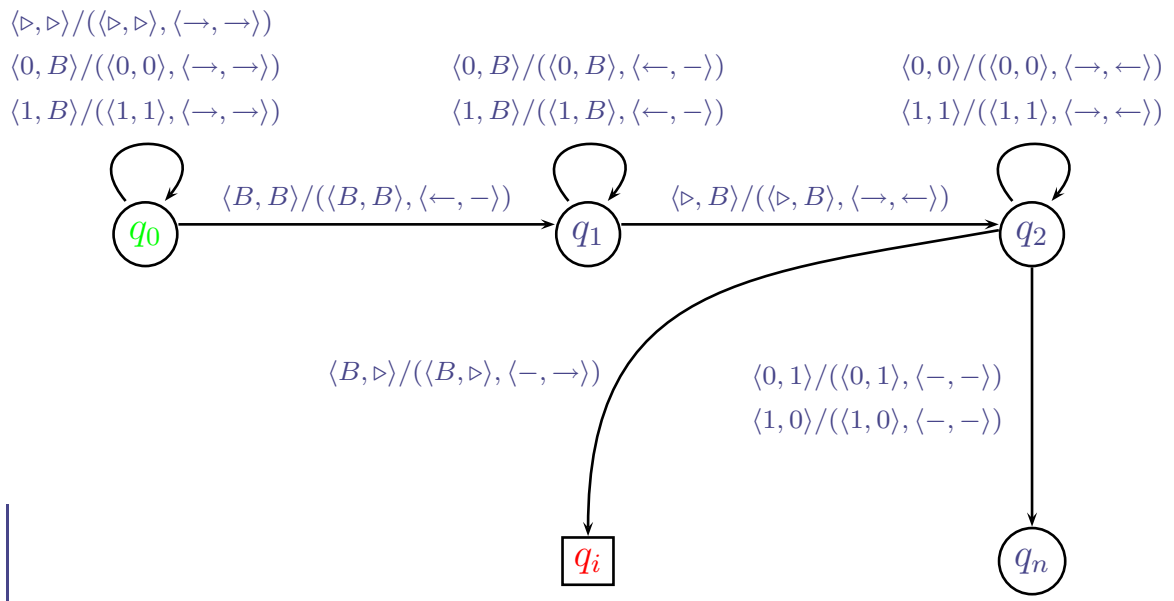

# A palindromákat eldöntő 2-szavas T-gép

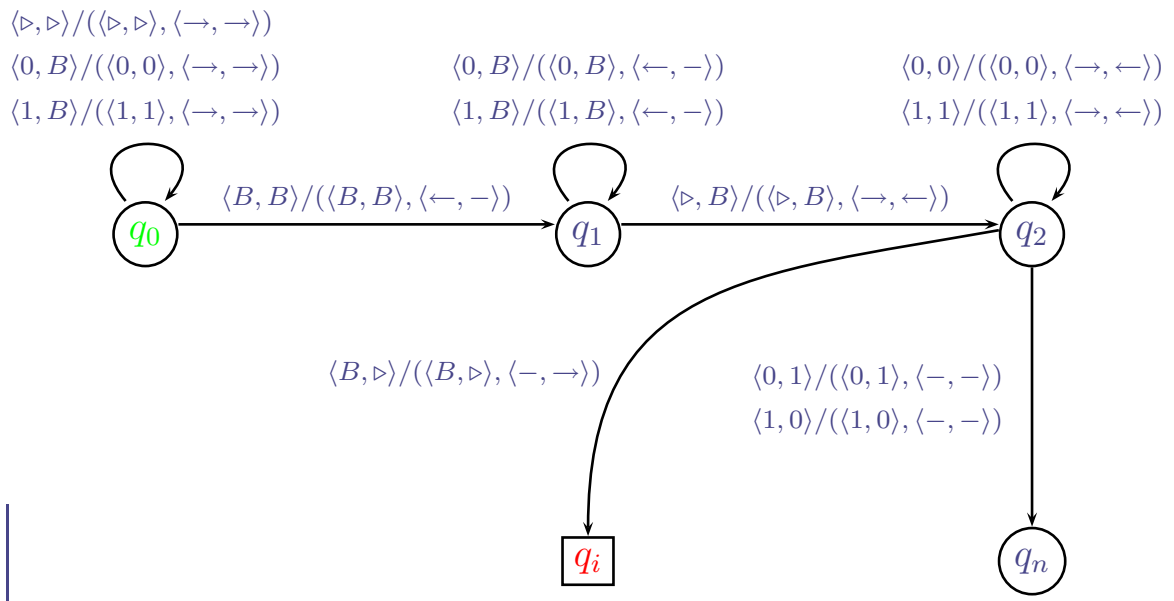
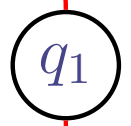
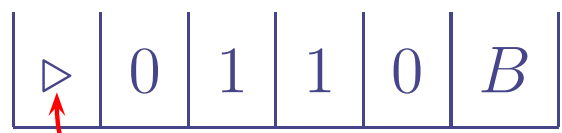

# A palindromákat eldöntő 2-szavas T-gép

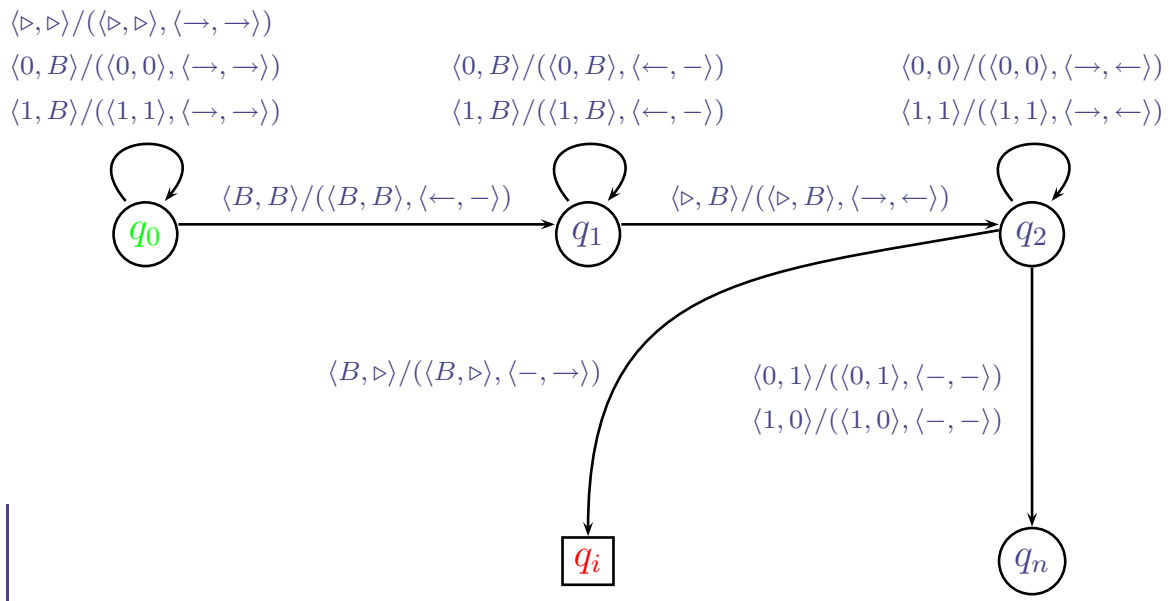

# A palindromákat eldöntő 2-szavas T-gép

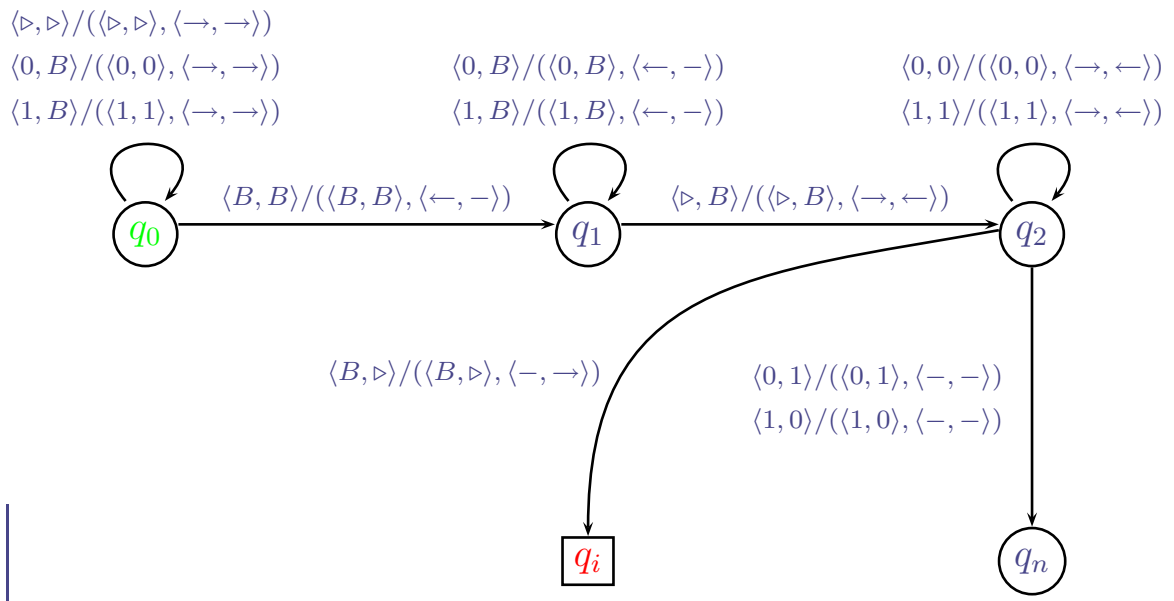
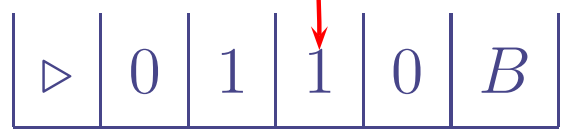
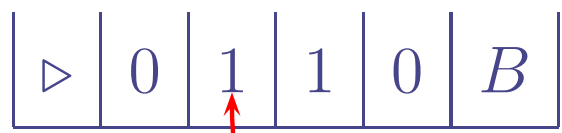

# A palindromákat eldöntő 2-szavas T-gép

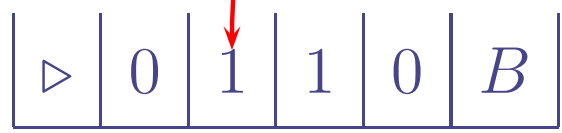
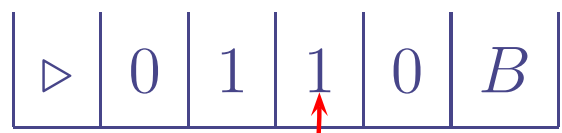

$\langle \triangleright, \triangleright \rangle / (\langle \triangleright, \triangleright \rangle, \langle \rightarrow, \rightarrow \rangle)$   
 $\langle 0, B \rangle / (\langle 0, 0 \rangle, \langle \rightarrow, \rightarrow \rangle)$   
 $\langle 1, B \rangle / (\langle 1, 1 \rangle, \langle \rightarrow, \rightarrow \rangle)$

$\langle 0, B \rangle / (\langle 0, B \rangle, \langle \leftarrow, - \rangle)$   
 $\langle 1, B \rangle / (\langle 1, B \rangle, \langle \leftarrow, - \rangle)$

$\langle 0, 0 \rangle / (\langle 0, 0 \rangle, \langle \rightarrow, \leftarrow \rangle)$   
 $\langle 1, 1 \rangle / (\langle 1, 1 \rangle, \langle \rightarrow, \leftarrow \rangle)$

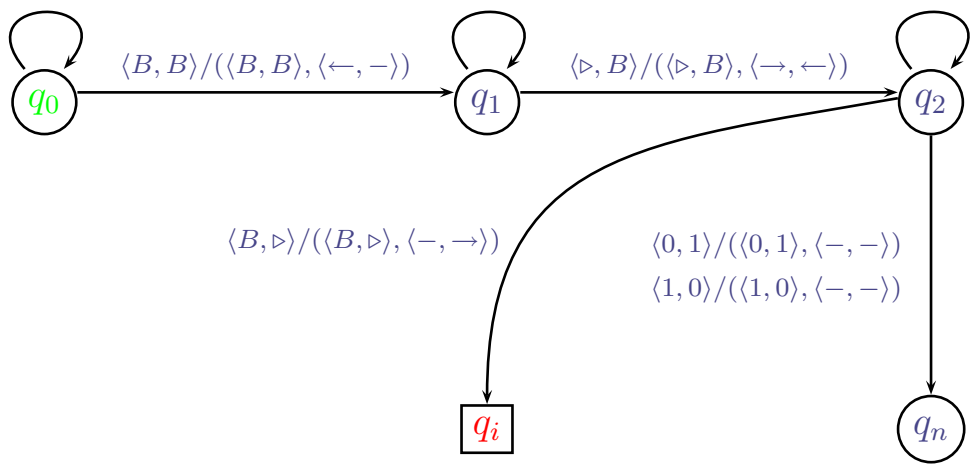

# A palindromákat eldöntő 2-szavas T-gép

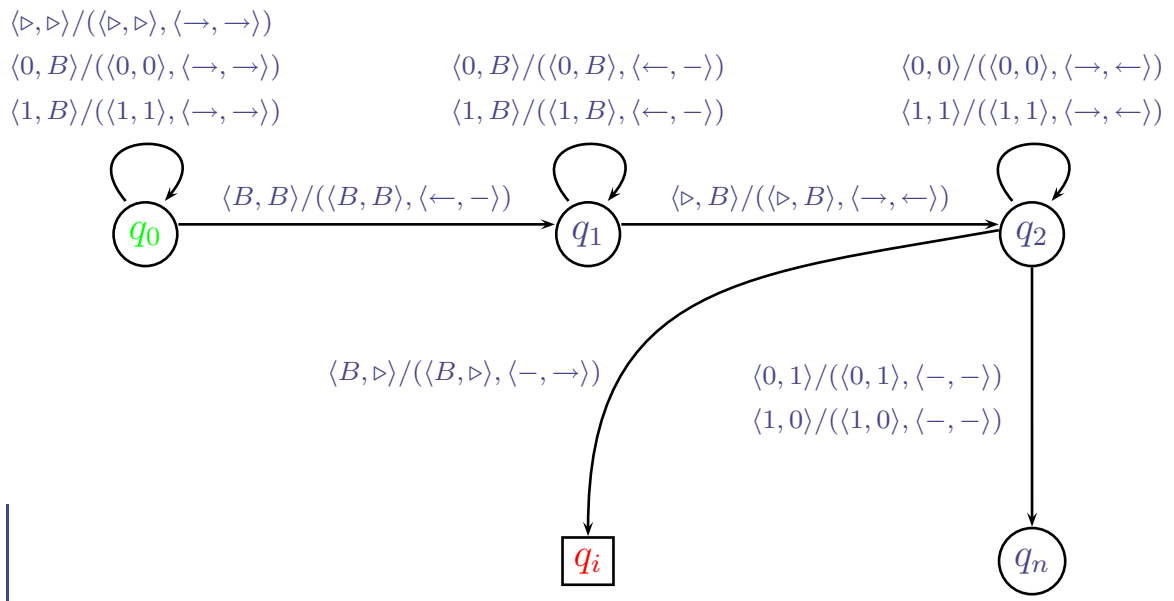
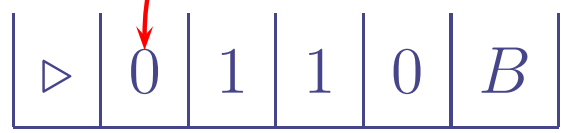

# A palindromákat eldöntő 2-szavas T-gép

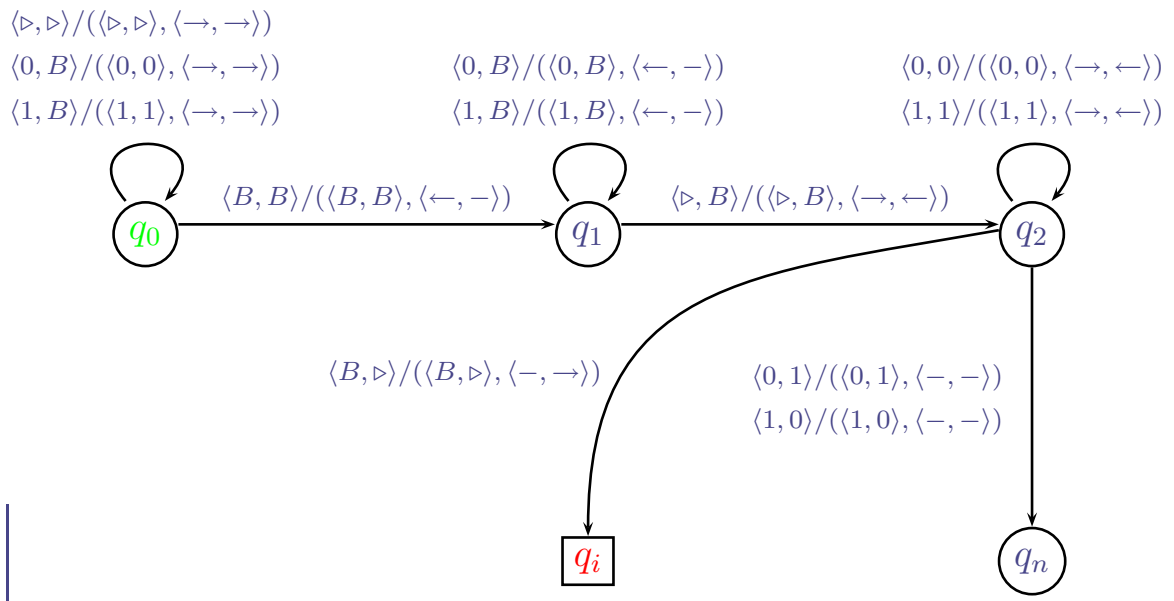
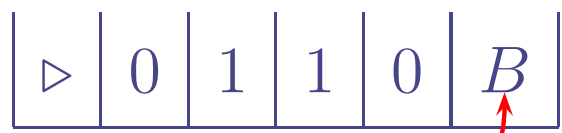



# A palindromákat eldöntő 2-szavas T-gép

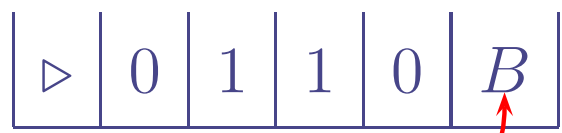

$q_i$

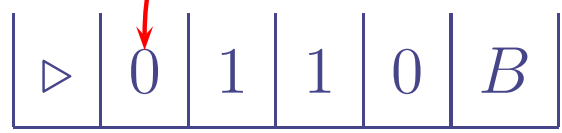

- $\langle \triangleright, \triangleright \rangle / (\langle \triangleright, \triangleright \rangle, \langle \rightarrow, \rightarrow \rangle)$
- $\langle 0, B \rangle / (\langle 0, 0 \rangle, \langle \rightarrow, \rightarrow \rangle)$
- $\langle 1, B \rangle / (\langle 1, 1 \rangle, \langle \rightarrow, \rightarrow \rangle)$
- $\langle 0, B \rangle / (\langle 0, B \rangle, \langle \leftarrow, - \rangle)$
- $\langle 1, B \rangle / (\langle 1, B \rangle, \langle \leftarrow, - \rangle)$
- $\langle 0, 0 \rangle / (\langle 0, 0 \rangle, \langle \rightarrow, \leftarrow \rangle)$
- $\langle 1, 1 \rangle / (\langle 1, 1 \rangle, \langle \rightarrow, \leftarrow \rangle)$

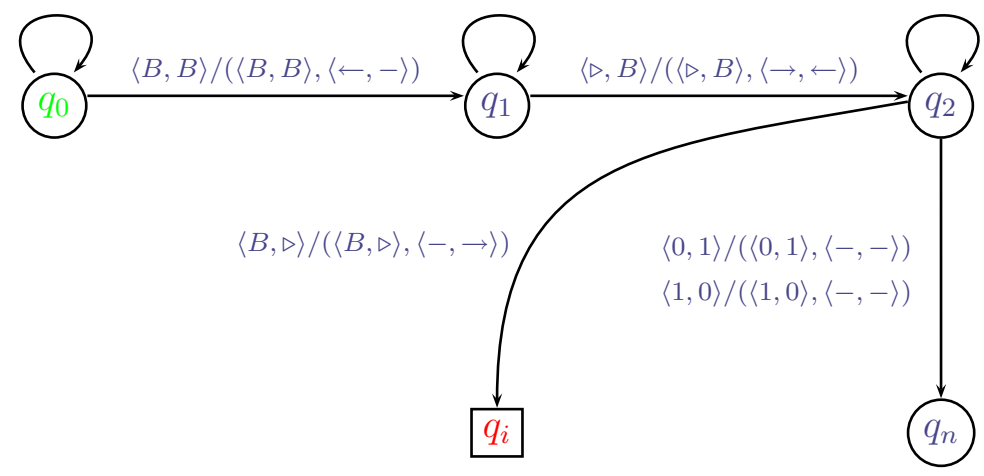

# A palindromákat eldöntő 2-szavas T-gép

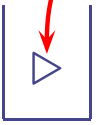
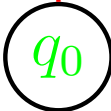

- $\langle \triangleright, \triangleright \rangle / (\langle \triangleright, \triangleright \rangle, \langle \rightarrow, \rightarrow \rangle)$
- $\langle 0, B \rangle / (\langle 0, 0 \rangle, \langle \rightarrow, \rightarrow \rangle)$
- $\langle 1, B \rangle / (\langle 1, 1 \rangle, \langle \rightarrow, \rightarrow \rangle)$
- $\langle 0, B \rangle / (\langle 0, B \rangle, \langle \leftarrow, - \rangle)$
- $\langle 1, B \rangle / (\langle 1, B \rangle, \langle \leftarrow, - \rangle)$
- $\langle 0, 0 \rangle / (\langle 0, 0 \rangle, \langle \rightarrow, \leftarrow \rangle)$
- $\langle 1, 1 \rangle / (\langle 1, 1 \rangle, \langle \rightarrow, \leftarrow \rangle)$

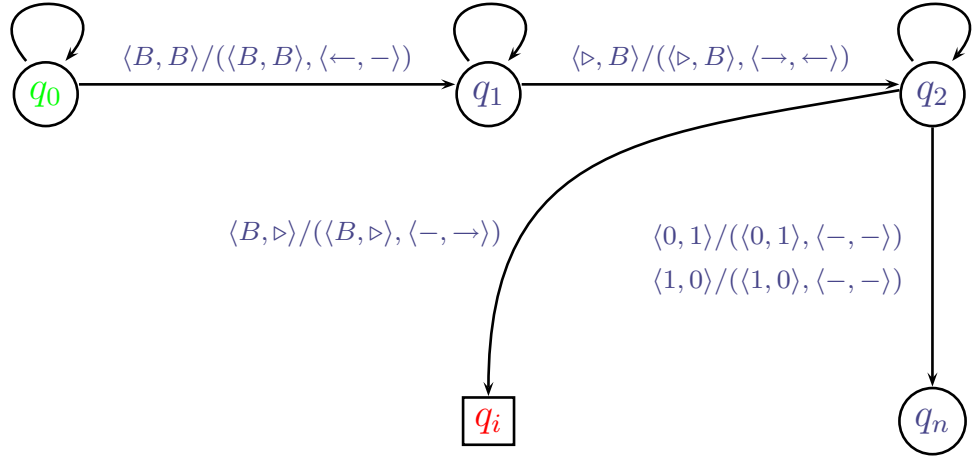

# A palindromákat eldöntő 2-szavas T-gép

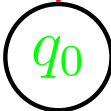
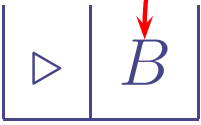

- $\langle \triangleright, \triangleright \rangle / (\langle \triangleright, \triangleright \rangle, \langle \rightarrow, \rightarrow \rangle)$
- $\langle 0, B \rangle / (\langle 0, 0 \rangle, \langle \rightarrow, \rightarrow \rangle)$
- $\langle 1, B \rangle / (\langle 1, 1 \rangle, \langle \rightarrow, \rightarrow \rangle)$
- $\langle 0, B \rangle / (\langle 0, B \rangle, \langle \leftarrow, - \rangle)$
- $\langle 1, B \rangle / (\langle 1, B \rangle, \langle \leftarrow, - \rangle)$
- $\langle 0, 0 \rangle / (\langle 0, 0 \rangle, \langle \rightarrow, \leftarrow \rangle)$
- $\langle 1, 1 \rangle / (\langle 1, 1 \rangle, \langle \rightarrow, \leftarrow \rangle)$

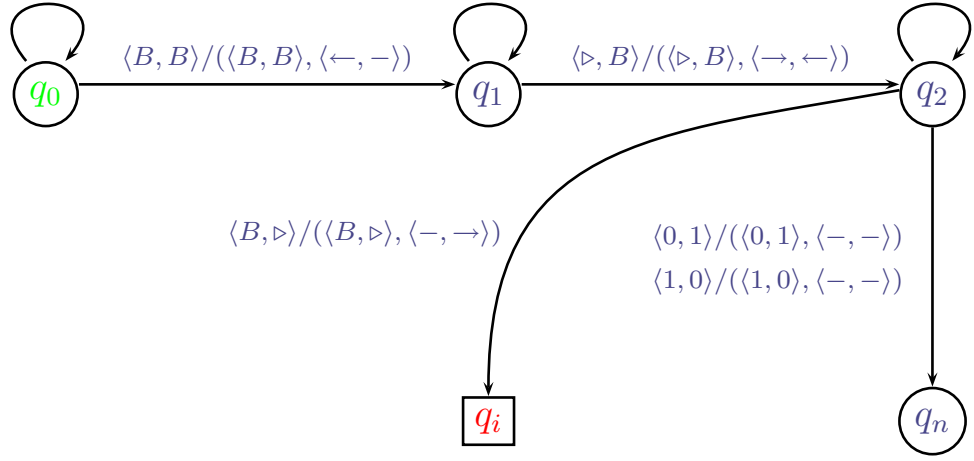

# A palindromákat eldöntő 2-szavas T-gép

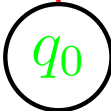
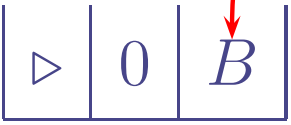

- $\langle \triangleright, \triangleright \rangle / (\langle \triangleright, \triangleright \rangle, \langle \rightarrow, \rightarrow \rangle)$
- $\langle 0, B \rangle / (\langle 0, 0 \rangle, \langle \rightarrow, \rightarrow \rangle)$
- $\langle 1, B \rangle / (\langle 1, 1 \rangle, \langle \rightarrow, \rightarrow \rangle)$
- $\langle 0, B \rangle / (\langle 0, B \rangle, \langle \leftarrow, - \rangle)$
- $\langle 1, B \rangle / (\langle 1, B \rangle, \langle \leftarrow, - \rangle)$
- $\langle 0, 0 \rangle / (\langle 0, 0 \rangle, \langle \rightarrow, \leftarrow \rangle)$
- $\langle 1, 1 \rangle / (\langle 1, 1 \rangle, \langle \rightarrow, \leftarrow \rangle)$

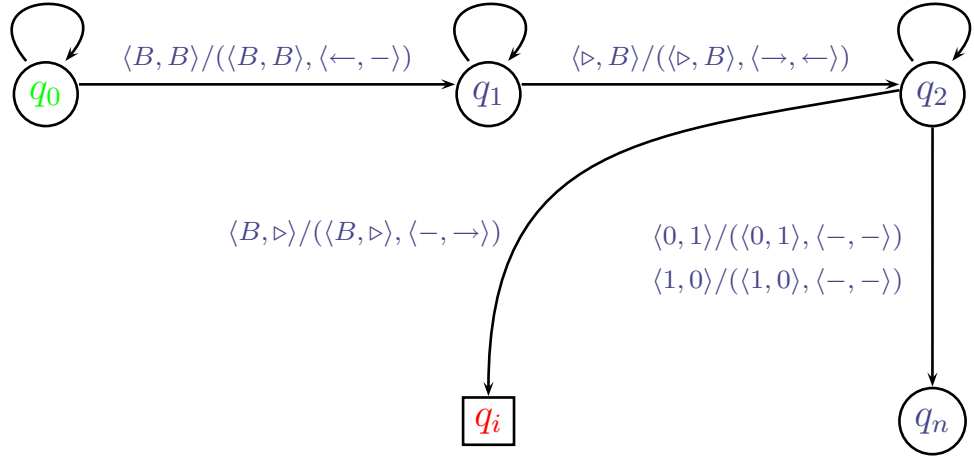

# A palindromákat eldöntő 2-szavas T-gép

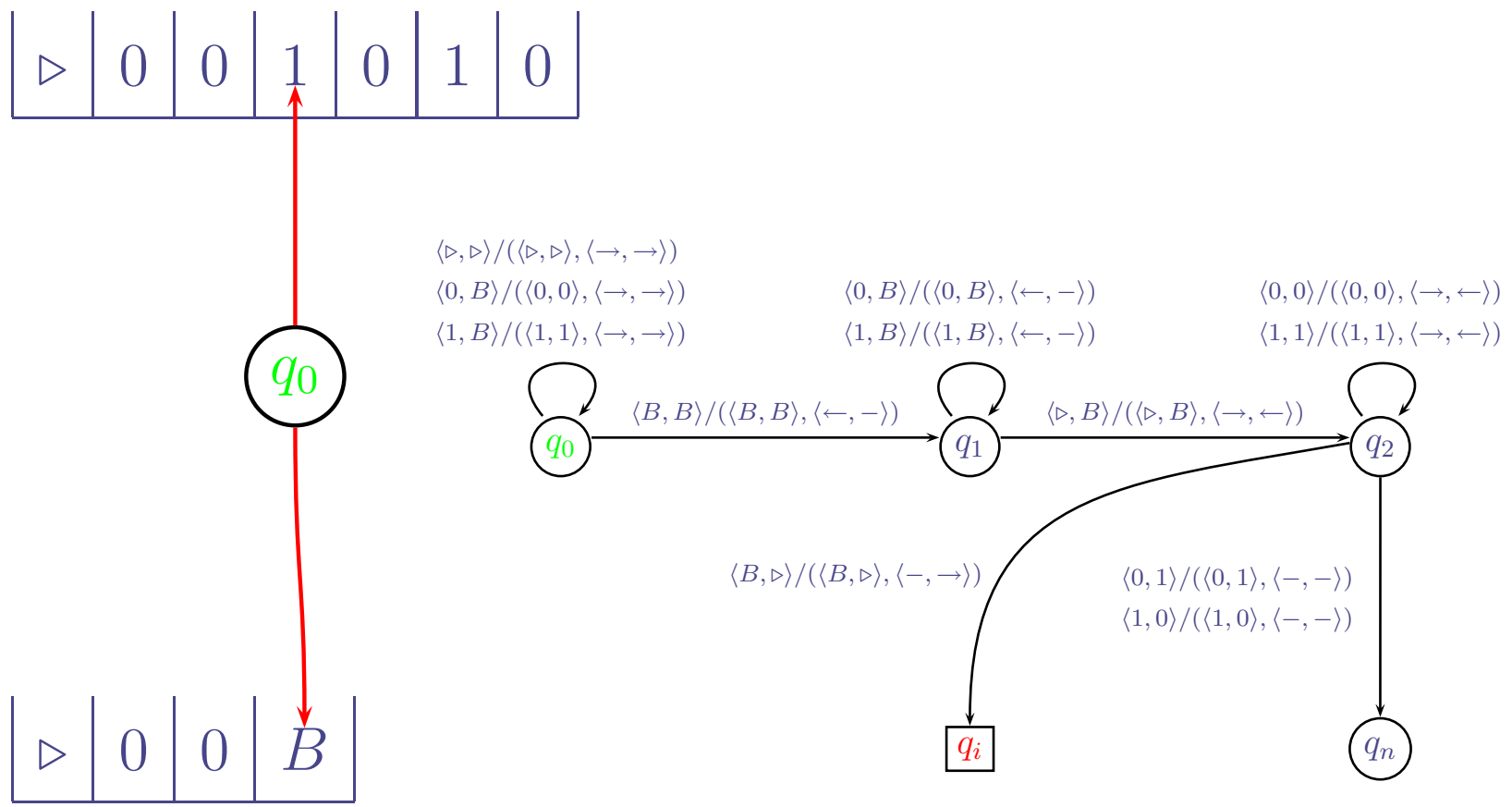

# A palindromákat eldöntő 2-szavas T-gép

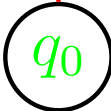

- $\langle \triangleright, \triangleright \rangle / (\langle \triangleright, \triangleright \rangle, \langle \rightarrow, \rightarrow \rangle)$
- $\langle 0, B \rangle / (\langle 0, 0 \rangle, \langle \rightarrow, \rightarrow \rangle)$
- $\langle 1, B \rangle / (\langle 1, 1 \rangle, \langle \rightarrow, \rightarrow \rangle)$
- $\langle 0, B \rangle / (\langle 0, B \rangle, \langle \leftarrow, - \rangle)$
- $\langle 1, B \rangle / (\langle 1, B \rangle, \langle \leftarrow, - \rangle)$
- $\langle 0, 0 \rangle / (\langle 0, 0 \rangle, \langle \rightarrow, \leftarrow \rangle)$
- $\langle 1, 1 \rangle / (\langle 1, 1 \rangle, \langle \rightarrow, \leftarrow \rangle)$

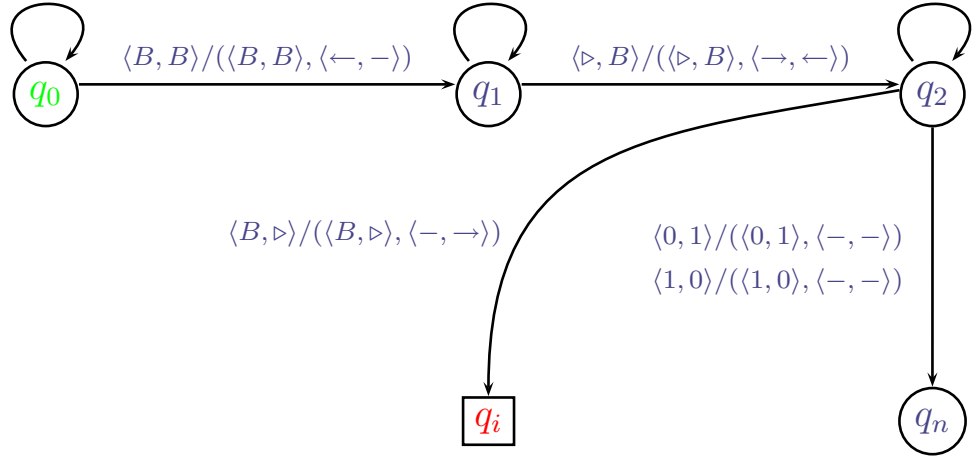

# A palindromákat eldöntő 2-szavas T-gép

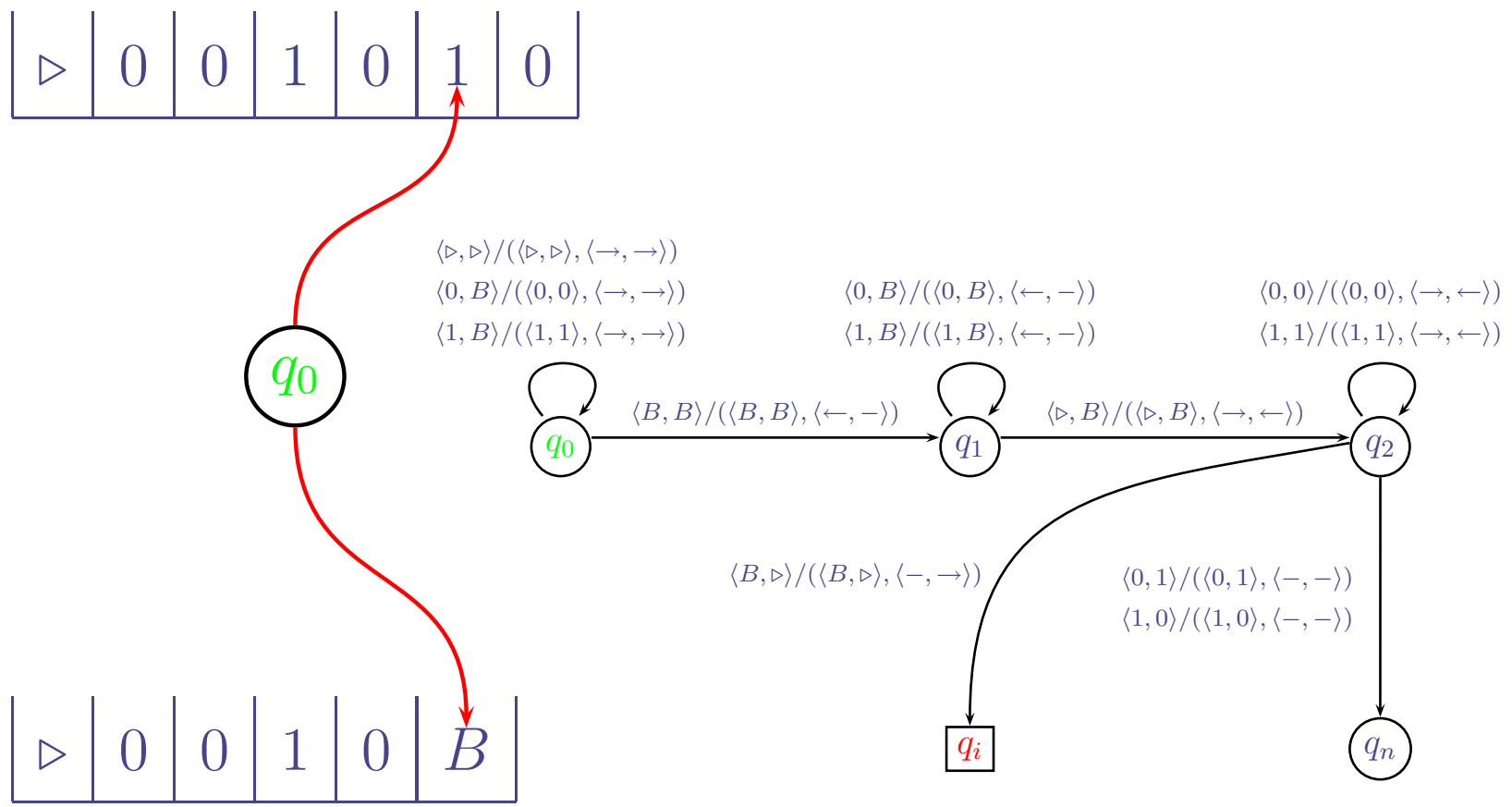

# A palindromákat eldöntő 2-szavas T-gép

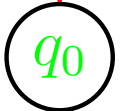

$\langle \triangleright, \triangleright \rangle / (\langle \triangleright, \triangleright \rangle, \langle \rightarrow, \rightarrow \rangle)$   
 $\langle 0, B \rangle / (\langle 0, 0 \rangle, \langle \rightarrow, \rightarrow \rangle)$   
 $\langle 1, B \rangle / (\langle 1, 1 \rangle, \langle \rightarrow, \rightarrow \rangle)$

$\langle 0, B \rangle / (\langle 0, B \rangle, \langle \leftarrow, - \rangle)$   
 $\langle 1, B \rangle / (\langle 1, B \rangle, \langle \leftarrow, - \rangle)$

$\langle 0, 0 \rangle / (\langle 0, 0 \rangle, \langle \rightarrow, \leftarrow \rangle)$   
 $\langle 1, 1 \rangle / (\langle 1, 1 \rangle, \langle \rightarrow, \leftarrow \rangle)$

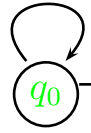

$\langle B, B \rangle / (\langle B, B \rangle, \langle \leftarrow, - \rangle)$

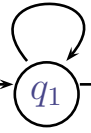

$\langle \triangleright, B \rangle / (\langle \triangleright, B \rangle, \langle \rightarrow, \leftarrow \rangle)$

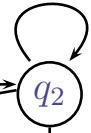

$\langle B, \triangleright \rangle / (\langle B, \triangleright \rangle, \langle -, \rightarrow \rangle)$

$\langle 0, 1 \rangle / (\langle 0, 1 \rangle, \langle -, - \rangle)$   
 $\langle 1, 0 \rangle / (\langle 1, 0 \rangle, \langle -, - \rangle)$





# A palindromákat eldöntő 2-szavas T-gép



$\langle \triangleright, \triangleright \rangle / (\langle \triangleright, \triangleright \rangle, \langle \rightarrow, \rightarrow \rangle)$   
 $\langle 0, B \rangle / (\langle 0, 0 \rangle, \langle \rightarrow, \rightarrow \rangle)$   
 $\langle 1, B \rangle / (\langle 1, 1 \rangle, \langle \rightarrow, \rightarrow \rangle)$

$\langle 0, B \rangle / (\langle 0, B \rangle, \langle \leftarrow, - \rangle)$   
 $\langle 1, B \rangle / (\langle 1, B \rangle, \langle \leftarrow, - \rangle)$

$\langle 0, 0 \rangle / (\langle 0, 0 \rangle, \langle \rightarrow, \leftarrow \rangle)$   
 $\langle 1, 1 \rangle / (\langle 1, 1 \rangle, \langle \rightarrow, \leftarrow \rangle)$



$\langle B, B \rangle / (\langle B, B \rangle, \langle \leftarrow, - \rangle)$

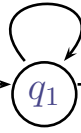

$\langle \triangleright, B \rangle / (\langle \triangleright, B \rangle, \langle \rightarrow, \leftarrow \rangle)$



$\langle B, \triangleright \rangle / (\langle B, \triangleright \rangle, \langle -, \rightarrow \rangle)$

$\langle 0, 1 \rangle / (\langle 0, 1 \rangle, \langle -, - \rangle)$   
 $\langle 1, 0 \rangle / (\langle 1, 0 \rangle, \langle -, - \rangle)$



# A palindromákat eldöntő 2-szavas T-gép

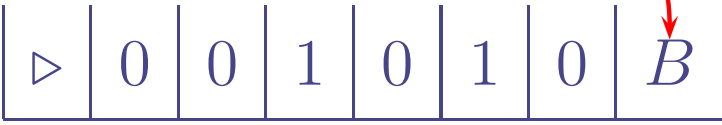
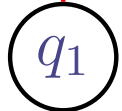

- $\langle \triangleright, \triangleright \rangle / (\langle \triangleright, \triangleright \rangle, \langle \rightarrow, \rightarrow \rangle)$
- $\langle 0, B \rangle / (\langle 0, 0 \rangle, \langle \rightarrow, \rightarrow \rangle)$
- $\langle 1, B \rangle / (\langle 1, 1 \rangle, \langle \rightarrow, \rightarrow \rangle)$
- $\langle 0, B \rangle / (\langle 0, B \rangle, \langle \leftarrow, - \rangle)$
- $\langle 1, B \rangle / (\langle 1, B \rangle, \langle \leftarrow, - \rangle)$
- $\langle 0, 0 \rangle / (\langle 0, 0 \rangle, \langle \rightarrow, \leftarrow \rangle)$
- $\langle 1, 1 \rangle / (\langle 1, 1 \rangle, \langle \rightarrow, \leftarrow \rangle)$

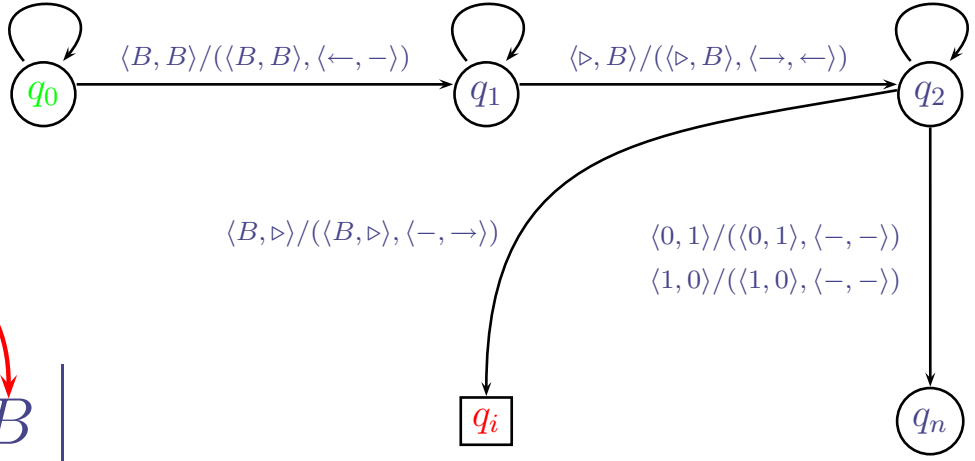

# A palindromákat eldöntő 2-szavas T-gép

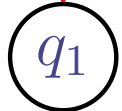

- $\langle \triangleright, \triangleright \rangle / (\langle \triangleright, \triangleright \rangle, \langle \rightarrow, \rightarrow \rangle)$
- $\langle 0, B \rangle / (\langle 0, 0 \rangle, \langle \rightarrow, \rightarrow \rangle)$
- $\langle 1, B \rangle / (\langle 1, 1 \rangle, \langle \rightarrow, \rightarrow \rangle)$
- $\langle 0, B \rangle / (\langle 0, B \rangle, \langle \leftarrow, - \rangle)$
- $\langle 1, B \rangle / (\langle 1, B \rangle, \langle \leftarrow, - \rangle)$
- $\langle 0, 0 \rangle / (\langle 0, 0 \rangle, \langle \rightarrow, \leftarrow \rangle)$
- $\langle 1, 1 \rangle / (\langle 1, 1 \rangle, \langle \rightarrow, \leftarrow \rangle)$

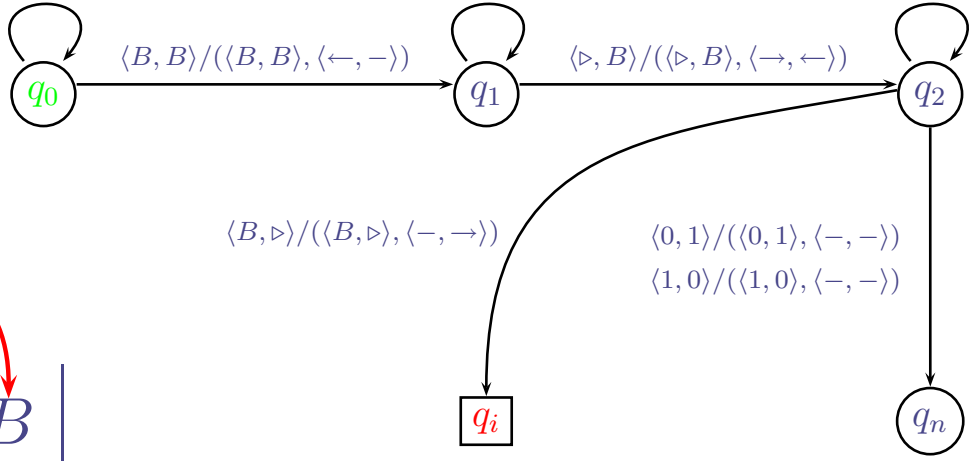

# A palindromákat eldöntő 2-szavas T-gép

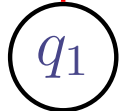
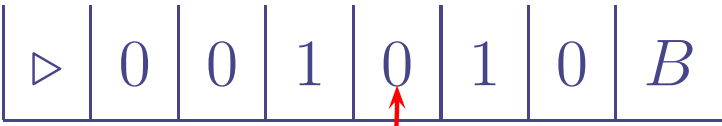

- $\langle \triangleright, \triangleright \rangle / (\langle \triangleright, \triangleright \rangle, \langle \rightarrow, \rightarrow \rangle)$
- $\langle 0, B \rangle / (\langle 0, 0 \rangle, \langle \rightarrow, \rightarrow \rangle)$
- $\langle 1, B \rangle / (\langle 1, 1 \rangle, \langle \rightarrow, \rightarrow \rangle)$
- $\langle 0, B \rangle / (\langle 0, B \rangle, \langle \leftarrow, - \rangle)$
- $\langle 1, B \rangle / (\langle 1, B \rangle, \langle \leftarrow, - \rangle)$
- $\langle 0, 0 \rangle / (\langle 0, 0 \rangle, \langle \rightarrow, \leftarrow \rangle)$
- $\langle 1, 1 \rangle / (\langle 1, 1 \rangle, \langle \rightarrow, \leftarrow \rangle)$

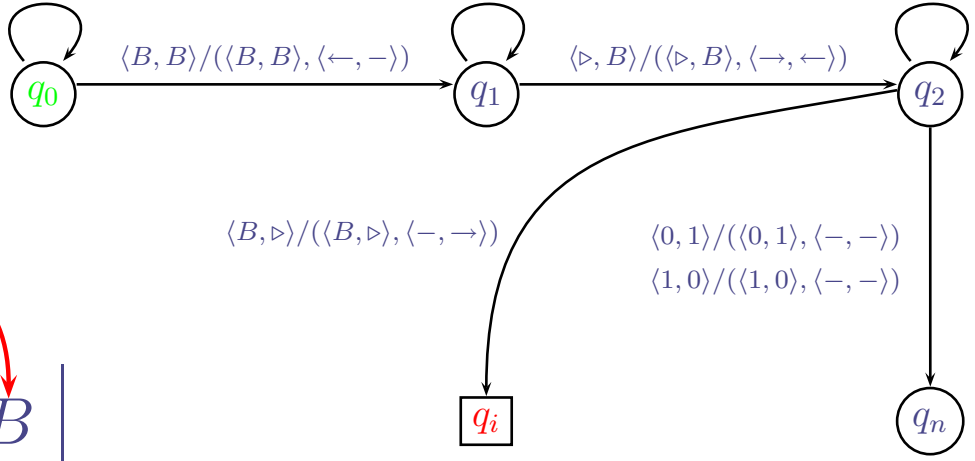

# A palindromákat eldöntő 2-szavas T-gép

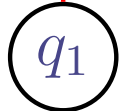
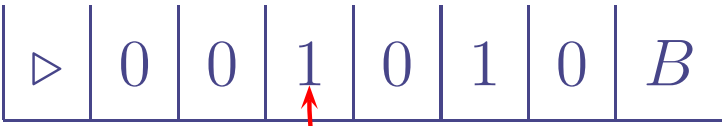

- $\langle \triangleright, \triangleright \rangle / (\langle \triangleright, \triangleright \rangle, \langle \rightarrow, \rightarrow \rangle)$
- $\langle 0, B \rangle / (\langle 0, 0 \rangle, \langle \rightarrow, \rightarrow \rangle)$
- $\langle 1, B \rangle / (\langle 1, 1 \rangle, \langle \rightarrow, \rightarrow \rangle)$
- $\langle 0, B \rangle / (\langle 0, B \rangle, \langle \leftarrow, - \rangle)$
- $\langle 1, B \rangle / (\langle 1, B \rangle, \langle \leftarrow, - \rangle)$
- $\langle 0, 0 \rangle / (\langle 0, 0 \rangle, \langle \rightarrow, \leftarrow \rangle)$
- $\langle 1, 1 \rangle / (\langle 1, 1 \rangle, \langle \rightarrow, \leftarrow \rangle)$

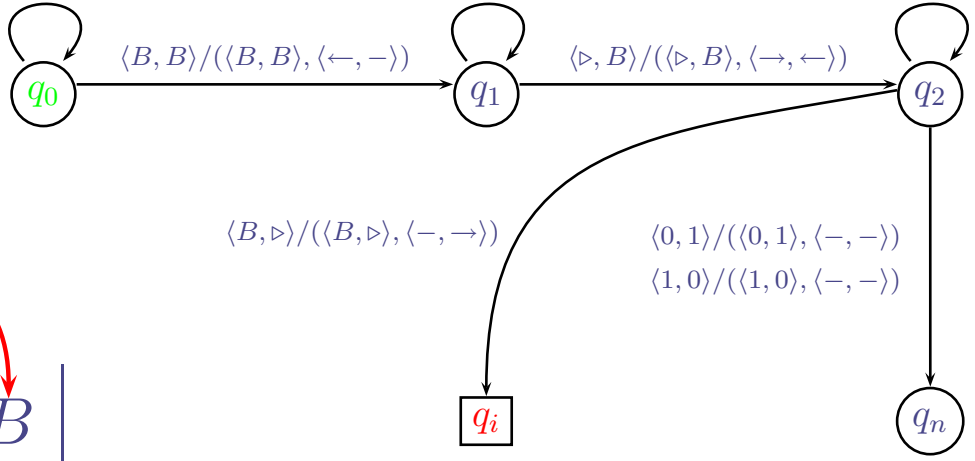

# A palindromákat eldöntő 2-szavas T-gép

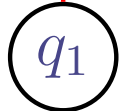

- $\langle \triangleright, \triangleright \rangle / (\langle \triangleright, \triangleright \rangle, \langle \rightarrow, \rightarrow \rangle)$
- $\langle 0, B \rangle / (\langle 0, 0 \rangle, \langle \rightarrow, \rightarrow \rangle)$
- $\langle 1, B \rangle / (\langle 1, 1 \rangle, \langle \rightarrow, \rightarrow \rangle)$
- $\langle 0, B \rangle / (\langle 0, B \rangle, \langle \leftarrow, - \rangle)$
- $\langle 1, B \rangle / (\langle 1, B \rangle, \langle \leftarrow, - \rangle)$
- $\langle 0, 0 \rangle / (\langle 0, 0 \rangle, \langle \rightarrow, \leftarrow \rangle)$
- $\langle 1, 1 \rangle / (\langle 1, 1 \rangle, \langle \rightarrow, \leftarrow \rangle)$

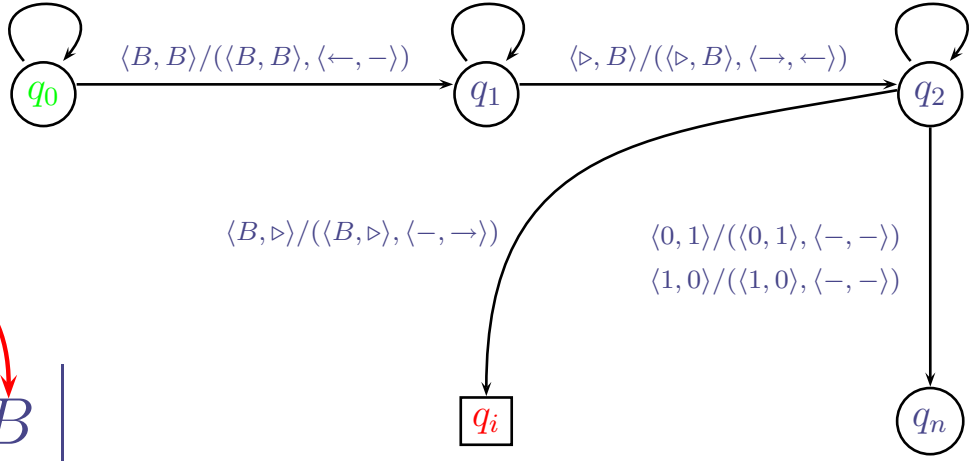

# A palindromákat eldöntő 2-szavas T-gép

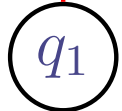

- $\langle \triangleright, \triangleright \rangle / (\langle \triangleright, \triangleright \rangle, \langle \rightarrow, \rightarrow \rangle)$
- $\langle 0, B \rangle / (\langle 0, 0 \rangle, \langle \rightarrow, \rightarrow \rangle)$
- $\langle 1, B \rangle / (\langle 1, 1 \rangle, \langle \rightarrow, \rightarrow \rangle)$
- $\langle 0, B \rangle / (\langle 0, B \rangle, \langle \leftarrow, - \rangle)$
- $\langle 1, B \rangle / (\langle 1, B \rangle, \langle \leftarrow, - \rangle)$
- $\langle 0, 0 \rangle / (\langle 0, 0 \rangle, \langle \rightarrow, \leftarrow \rangle)$
- $\langle 1, 1 \rangle / (\langle 1, 1 \rangle, \langle \rightarrow, \leftarrow \rangle)$

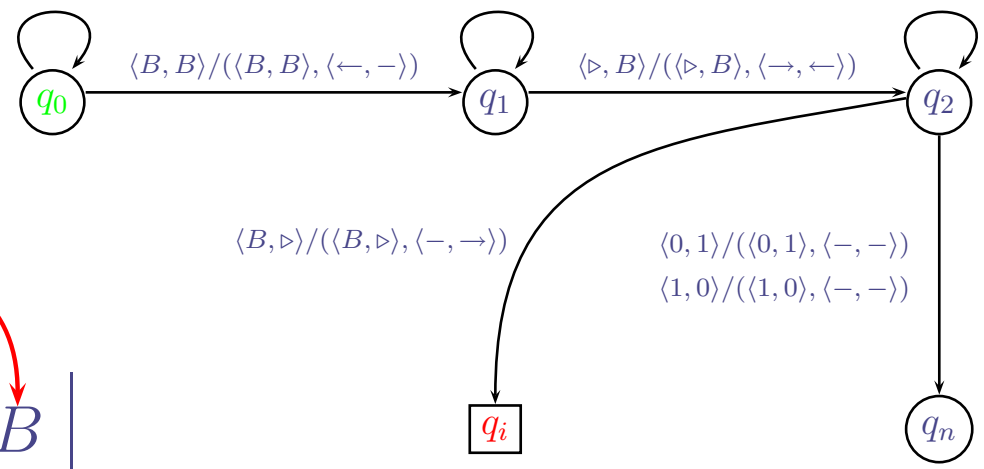

# A palindromákat eldöntő 2-szavas T-gép

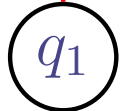

- $\langle \triangleright, \triangleright \rangle / (\langle \triangleright, \triangleright \rangle, \langle \rightarrow, \rightarrow \rangle)$
- $\langle 0, B \rangle / (\langle 0, 0 \rangle, \langle \rightarrow, \rightarrow \rangle)$
- $\langle 1, B \rangle / (\langle 1, 1 \rangle, \langle \rightarrow, \rightarrow \rangle)$
- $\langle 0, B \rangle / (\langle 0, B \rangle, \langle \leftarrow, - \rangle)$
- $\langle 1, B \rangle / (\langle 1, B \rangle, \langle \leftarrow, - \rangle)$
- $\langle 0, 0 \rangle / (\langle 0, 0 \rangle, \langle \rightarrow, \leftarrow \rangle)$
- $\langle 1, 1 \rangle / (\langle 1, 1 \rangle, \langle \rightarrow, \leftarrow \rangle)$

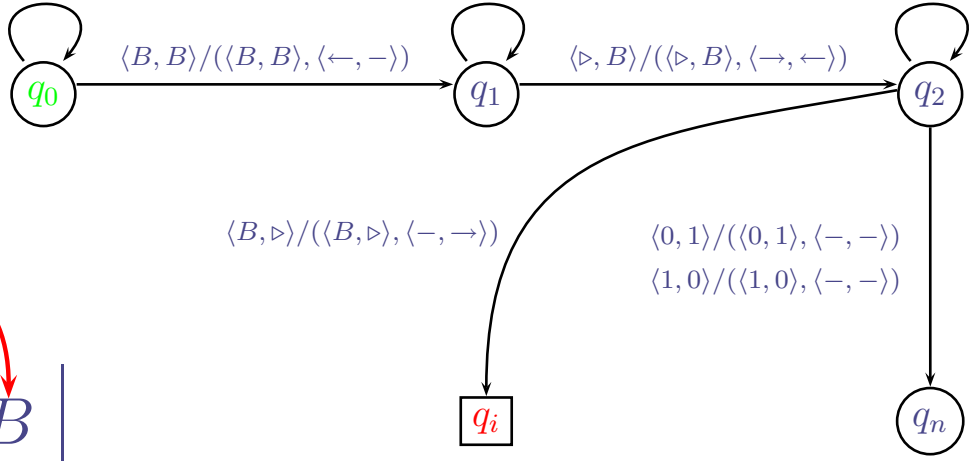



# A palindromákat eldöntő 2-szavas T-gép



- $\langle \triangleright, \triangleright \rangle / (\langle \triangleright, \triangleright \rangle, \langle \rightarrow, \rightarrow \rangle)$
- $\langle 0, B \rangle / (\langle 0, 0 \rangle, \langle \rightarrow, \rightarrow \rangle)$
- $\langle 1, B \rangle / (\langle 1, 1 \rangle, \langle \rightarrow, \rightarrow \rangle)$
- $\langle 0, B \rangle / (\langle 0, B \rangle, \langle \leftarrow, - \rangle)$
- $\langle 1, B \rangle / (\langle 1, B \rangle, \langle \leftarrow, - \rangle)$
- $\langle 0, 0 \rangle / (\langle 0, 0 \rangle, \langle \rightarrow, \leftarrow \rangle)$
- $\langle 1, 1 \rangle / (\langle 1, 1 \rangle, \langle \rightarrow, \leftarrow \rangle)$

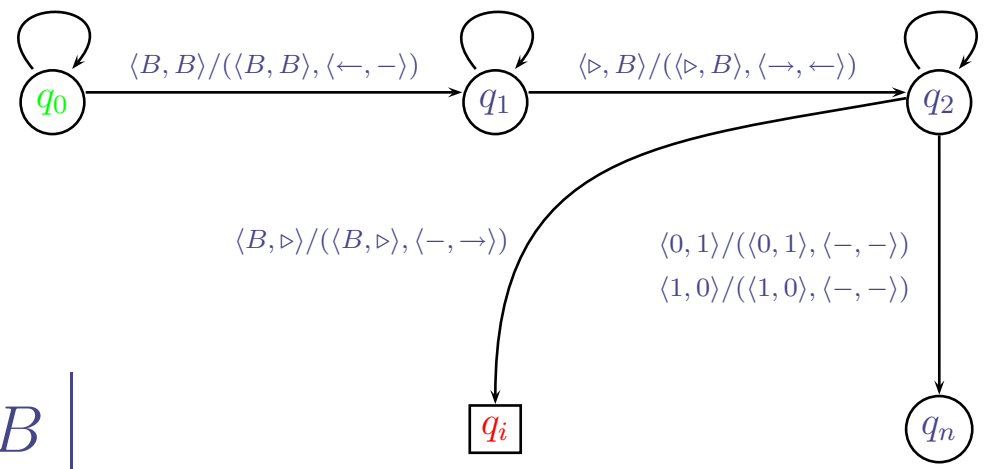

# A palindromákat eldöntő 2-szavas T-gép



- $\langle \triangleright, \triangleright \rangle / (\langle \triangleright, \triangleright \rangle, \langle \rightarrow, \rightarrow \rangle)$
- $\langle 0, B \rangle / (\langle 0, 0 \rangle, \langle \rightarrow, \rightarrow \rangle)$
- $\langle 1, B \rangle / (\langle 1, 1 \rangle, \langle \rightarrow, \rightarrow \rangle)$
- $\langle 0, B \rangle / (\langle 0, B \rangle, \langle \leftarrow, - \rangle)$
- $\langle 1, B \rangle / (\langle 1, B \rangle, \langle \leftarrow, - \rangle)$
- $\langle 0, 0 \rangle / (\langle 0, 0 \rangle, \langle \rightarrow, \leftarrow \rangle)$
- $\langle 1, 1 \rangle / (\langle 1, 1 \rangle, \langle \rightarrow, \leftarrow \rangle)$

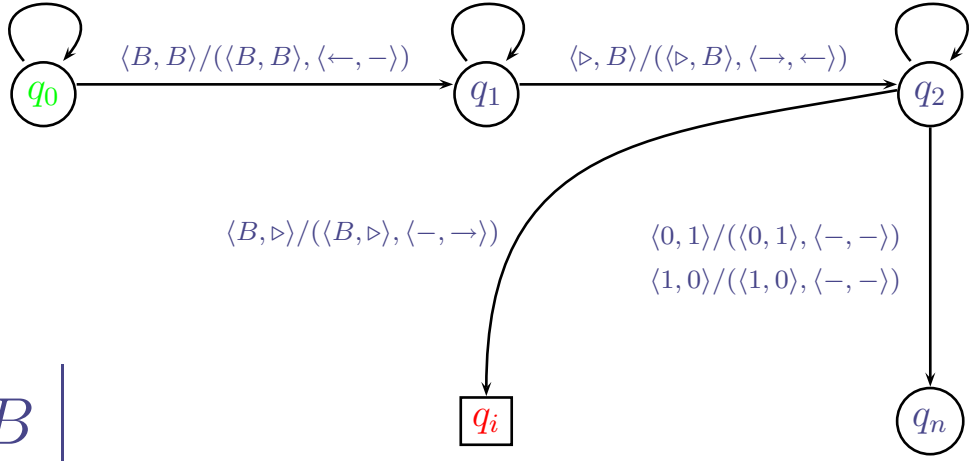

# A palindromákat eldöntő 2-szavas T-gép

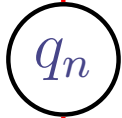

- $\langle \triangleright, \triangleright \rangle / (\langle \triangleright, \triangleright \rangle, \langle \rightarrow, \rightarrow \rangle)$
- $\langle 0, B \rangle / (\langle 0, 0 \rangle, \langle \rightarrow, \rightarrow \rangle)$
- $\langle 1, B \rangle / (\langle 1, 1 \rangle, \langle \rightarrow, \rightarrow \rangle)$
- $\langle 0, B \rangle / (\langle 0, B \rangle, \langle \leftarrow, - \rangle)$
- $\langle 1, B \rangle / (\langle 1, B \rangle, \langle \leftarrow, - \rangle)$
- $\langle 0, 0 \rangle / (\langle 0, 0 \rangle, \langle \rightarrow, \leftarrow \rangle)$
- $\langle 1, 1 \rangle / (\langle 1, 1 \rangle, \langle \rightarrow, \leftarrow \rangle)$

